

## **Rolls-Royce Silver Spur Limousine**

This section has been produced by  
Robert Jankel Design Limited

<b>Contents</b>	<b>Page</b>
Audio equipment	M29-3
Video unit and intercom	M29-7
Relay	M29-11
Video monitor	M29-15
Central division window lifts, refrigerator, and rear compartment interior lights	M29-19
Power distribution system	M29-23
Rear compartment air conditioning system	M29-27

## **Audio Equipment**

**Silver Spur limousine fitted with rear compartment Clarion G Compo radio, cassette tape play unit, graphic equaliser and amplifiers**

**Component location**

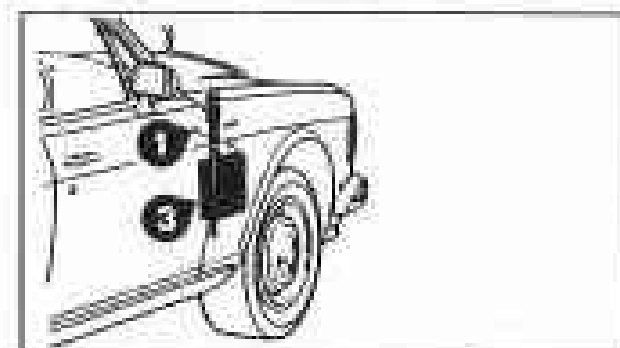
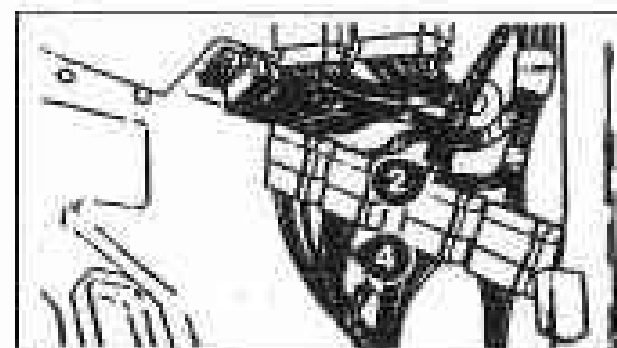
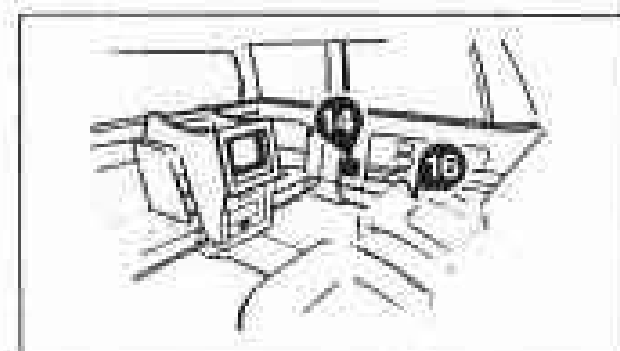
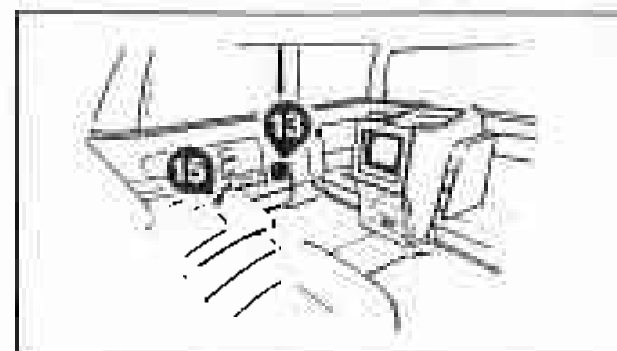
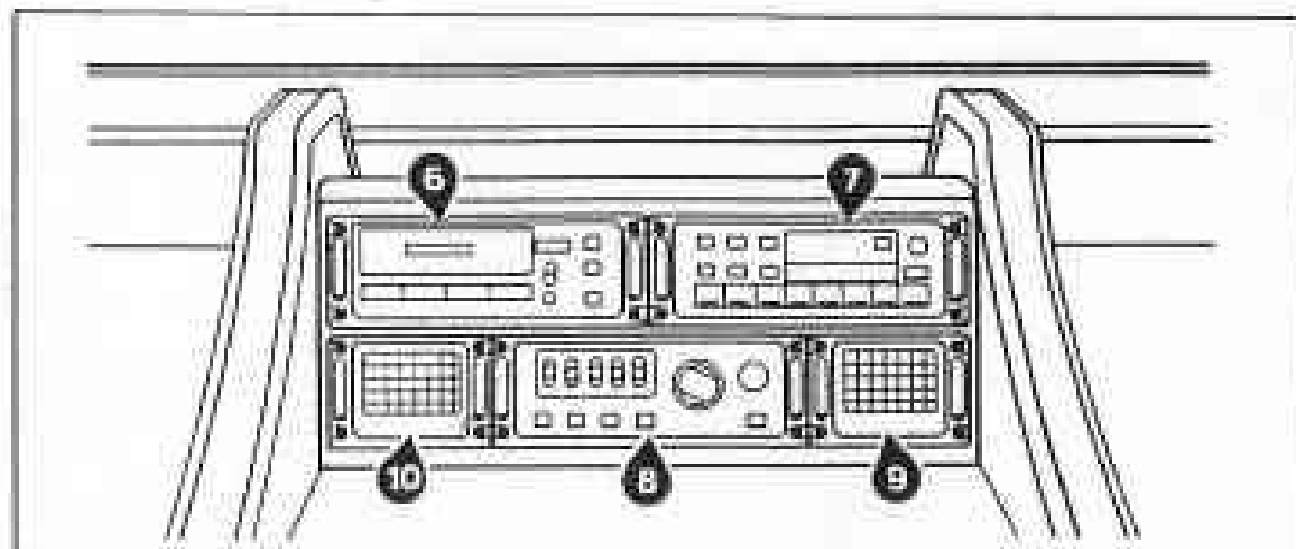
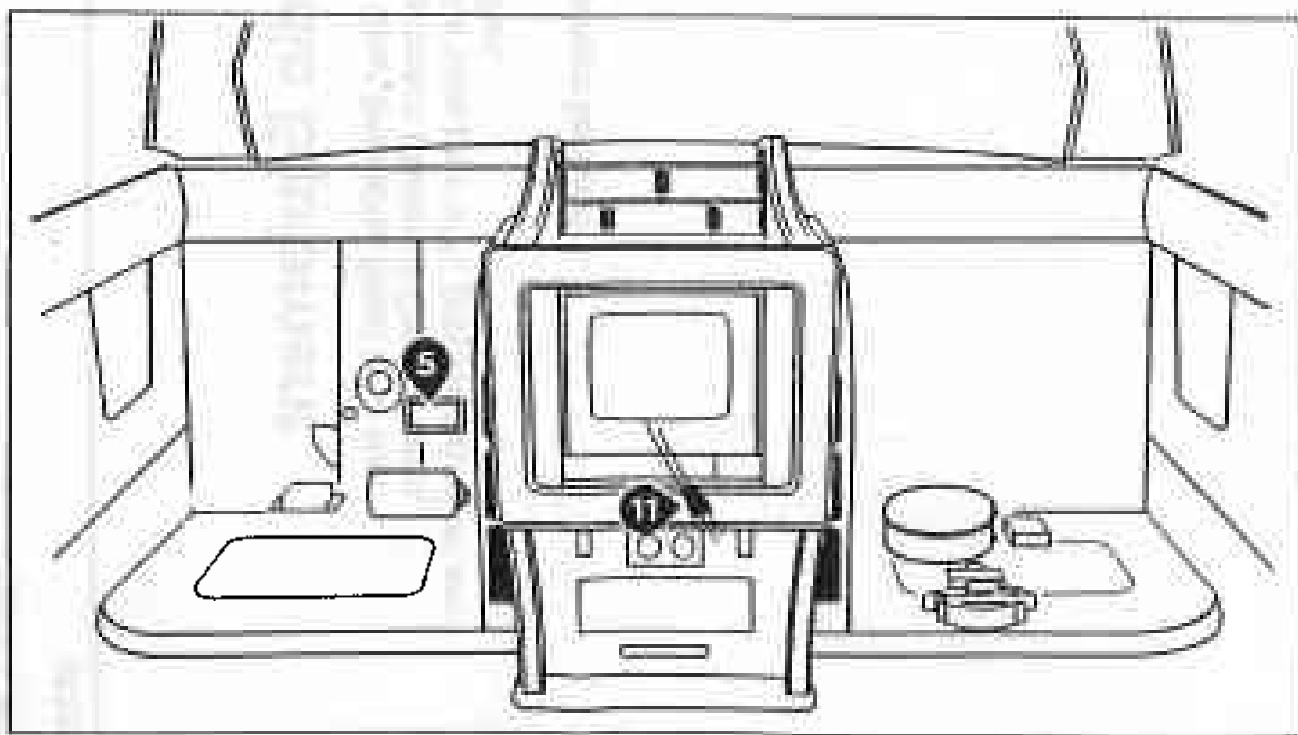
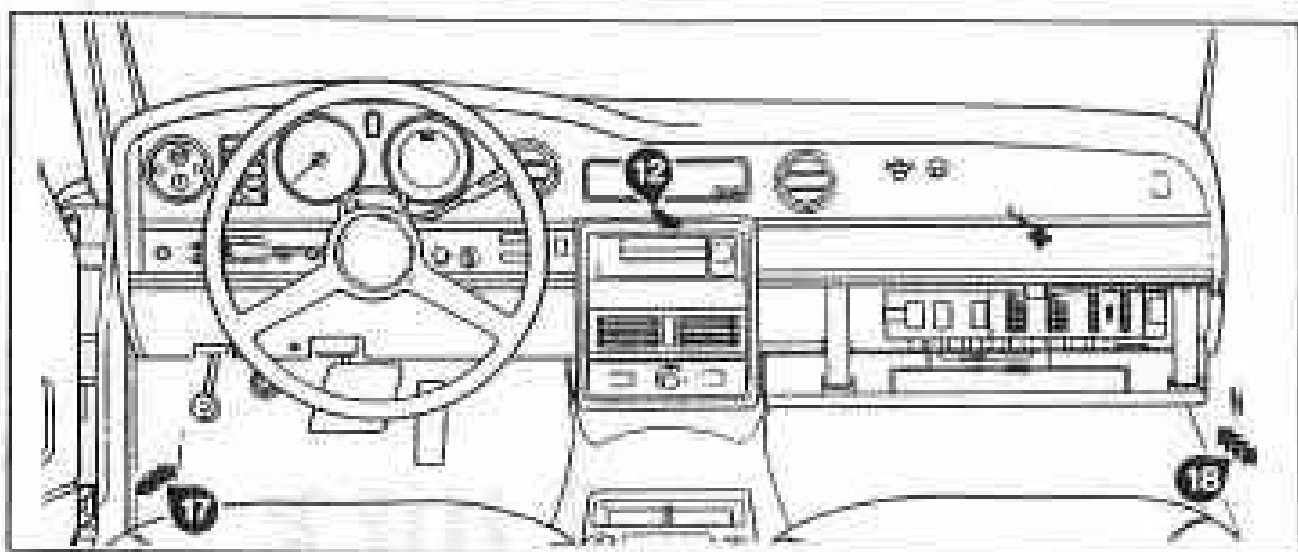
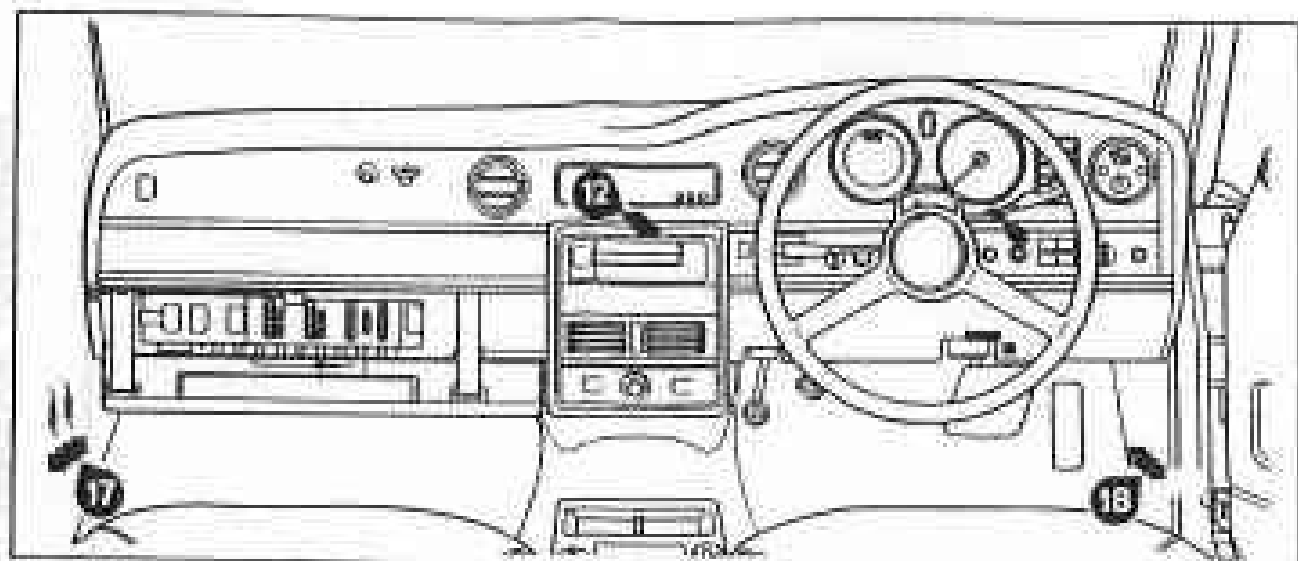

## **Audio Equipment**

Silver Spur limousine fitted with rear compartment Clarion G Compo radio, cassette tape play unit, graphic equaliser and amplifiers

Wiring diagram

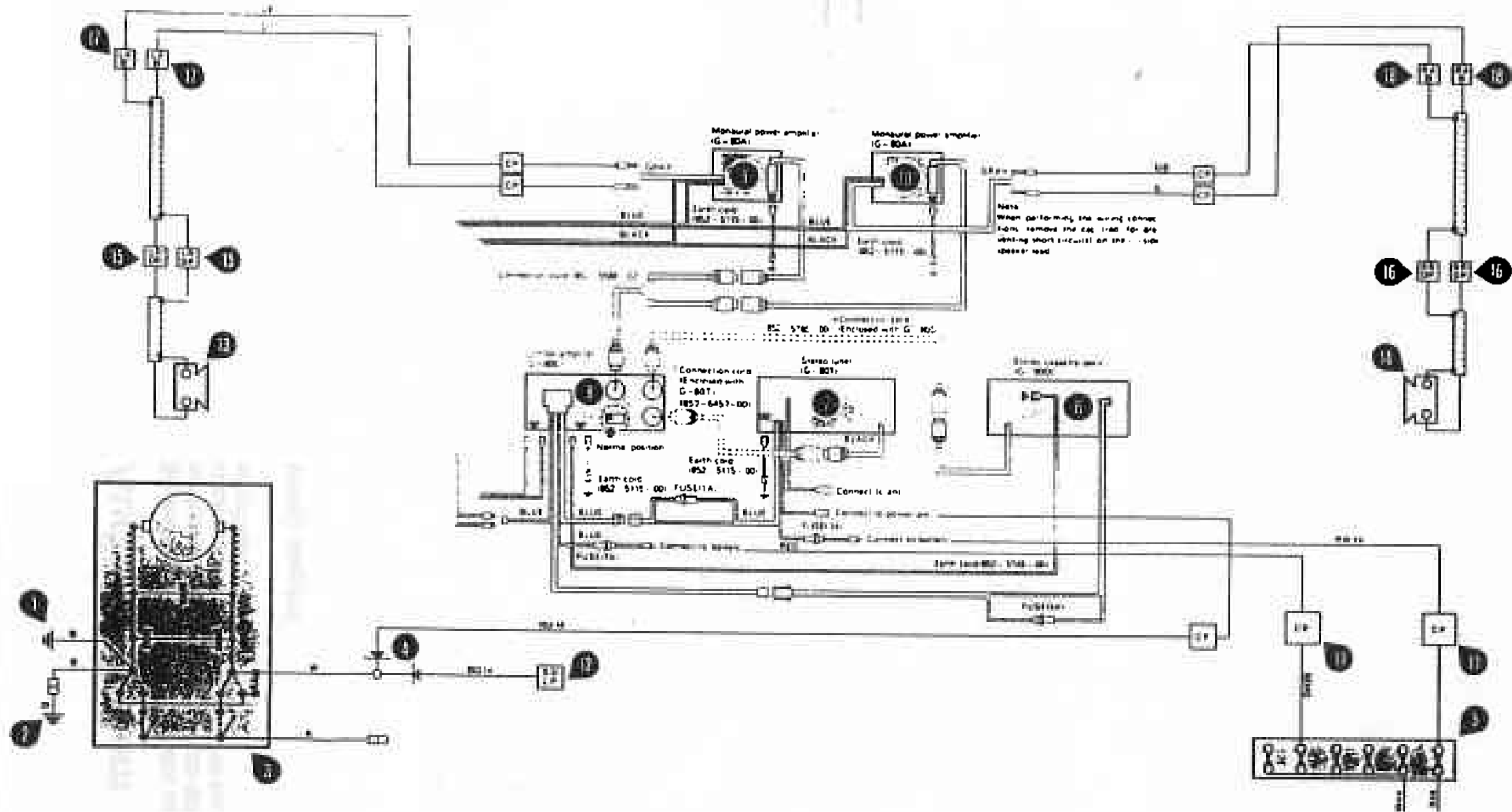

## Video Unit and Intercom

Silver Spur limousine fitted with Sony Betamax and National Panasonic video playback units

Component location

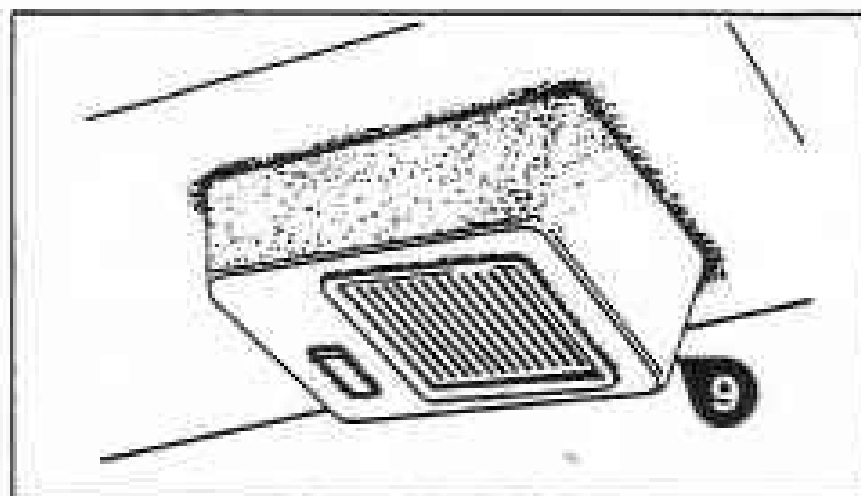
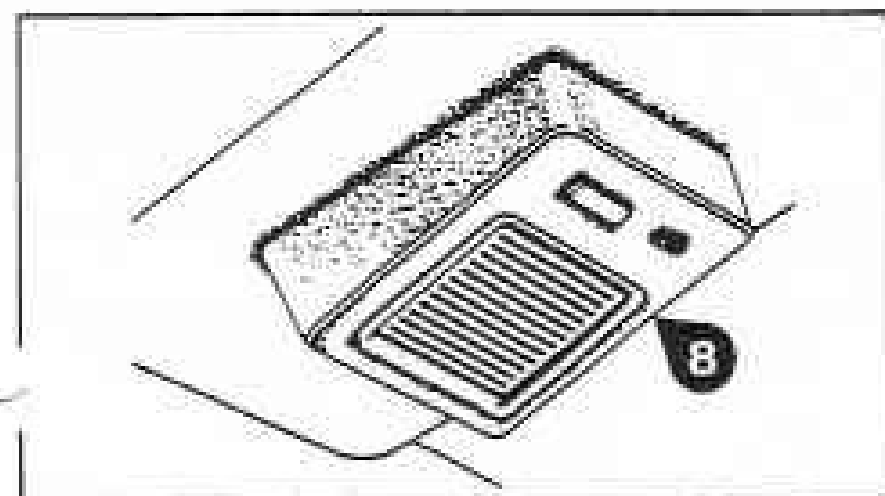
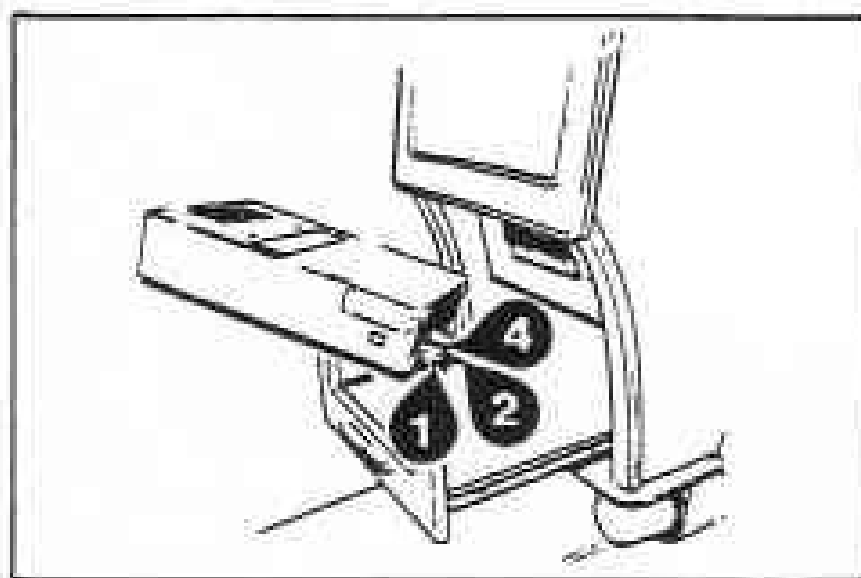
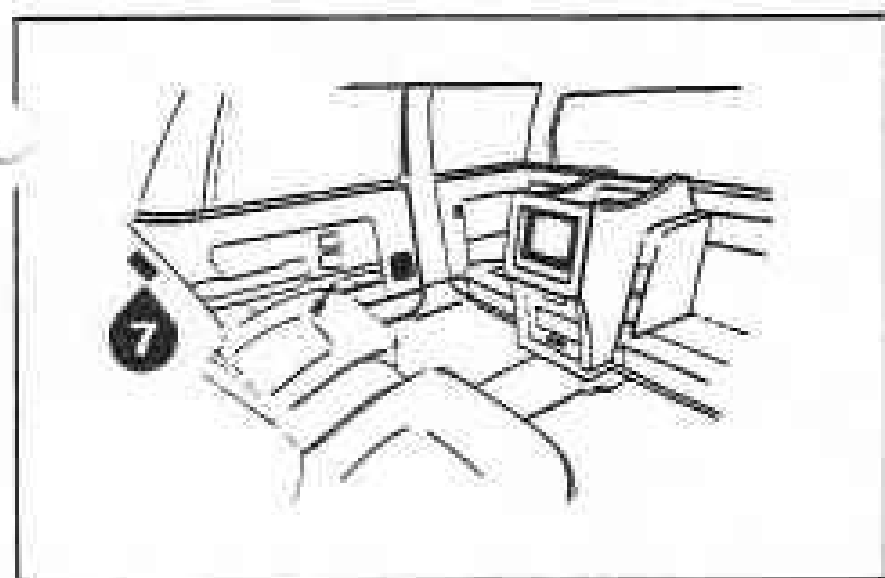
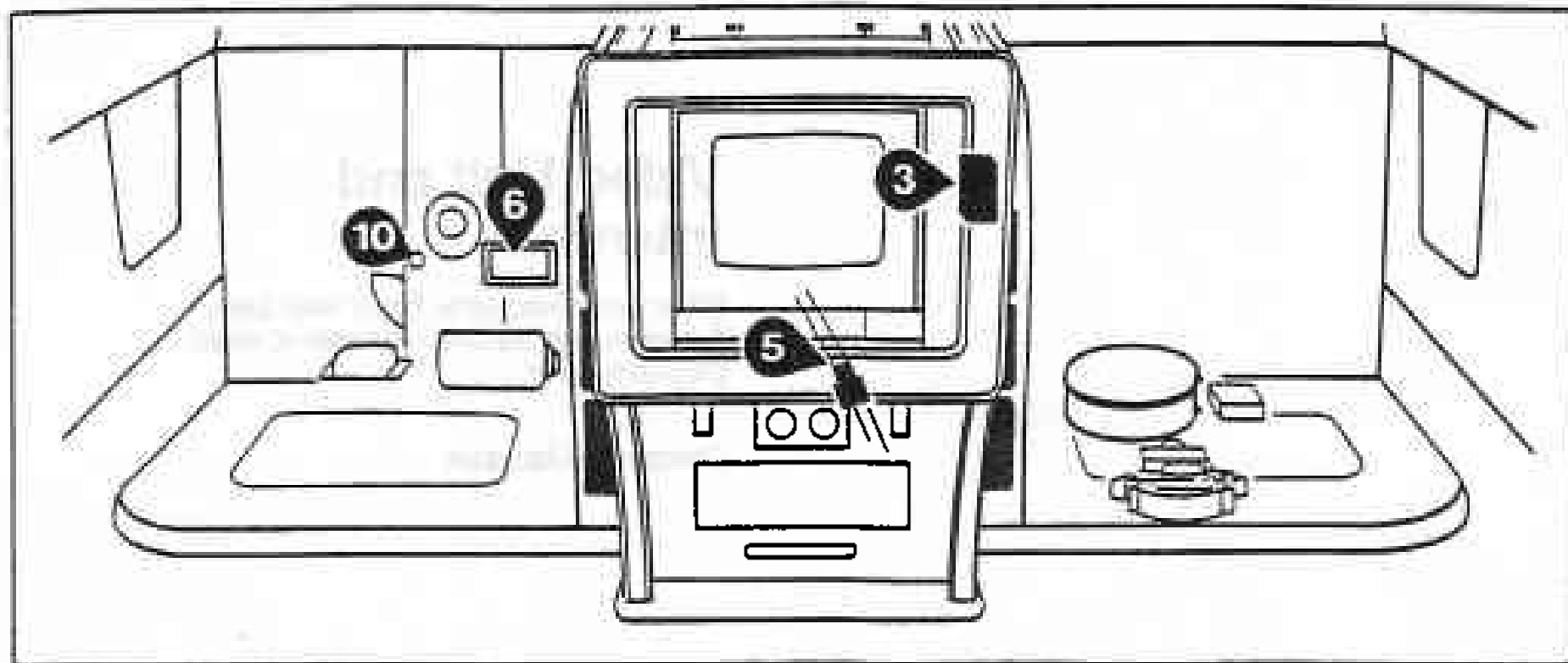

## **Video Unit and Intercom**

Silver Spur limousine fitted with Sony Betamax and National Panasonic video playback units

Wiring diagram

Aluminum Oxidation  
Experiment  
Circuit Diagram

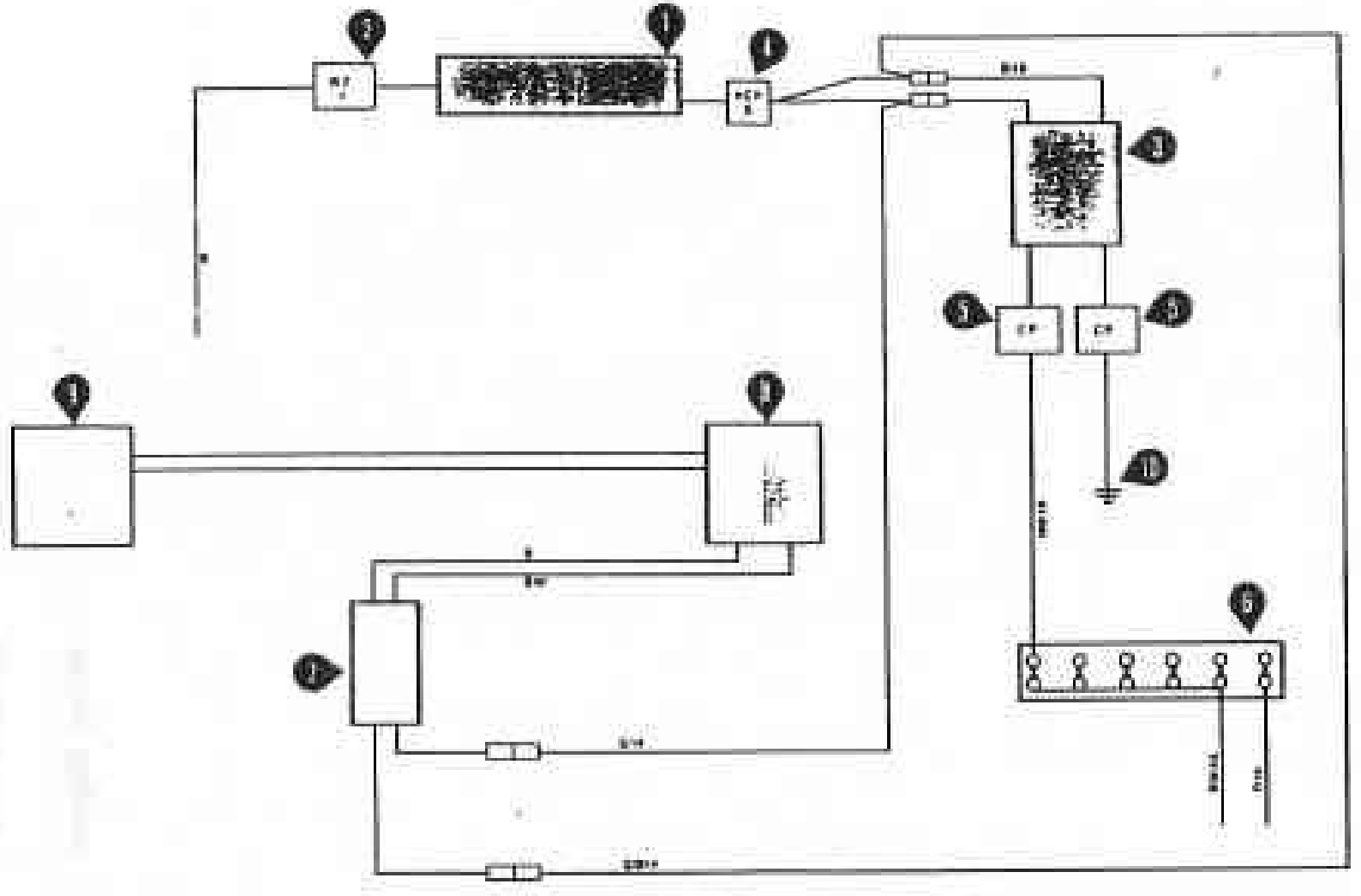

## **Relay**

Silver Spur limousine. Change over relay –  
video monitor to Clarion audio system

Component location

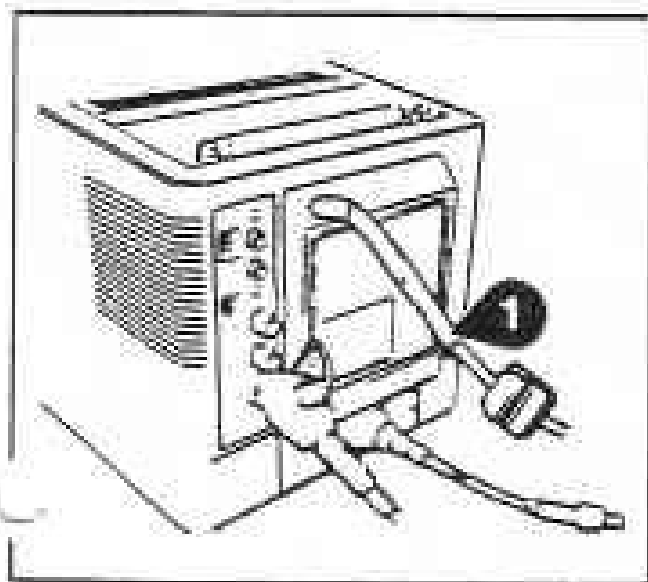
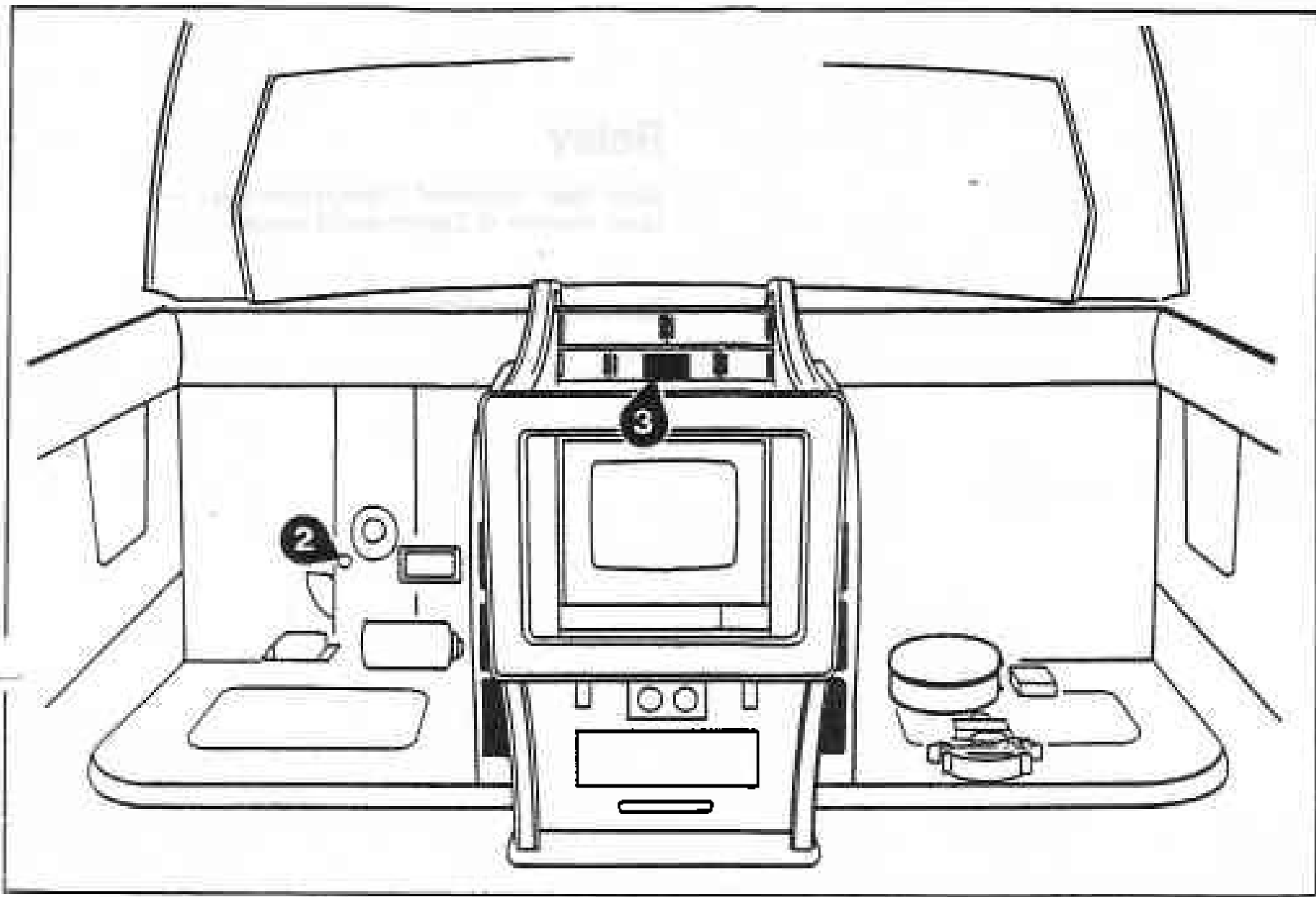

## **Relay**

**Silver Spur limousine. Change over relay –  
video monitor to Clarion audio system**

**Wiring diagram**

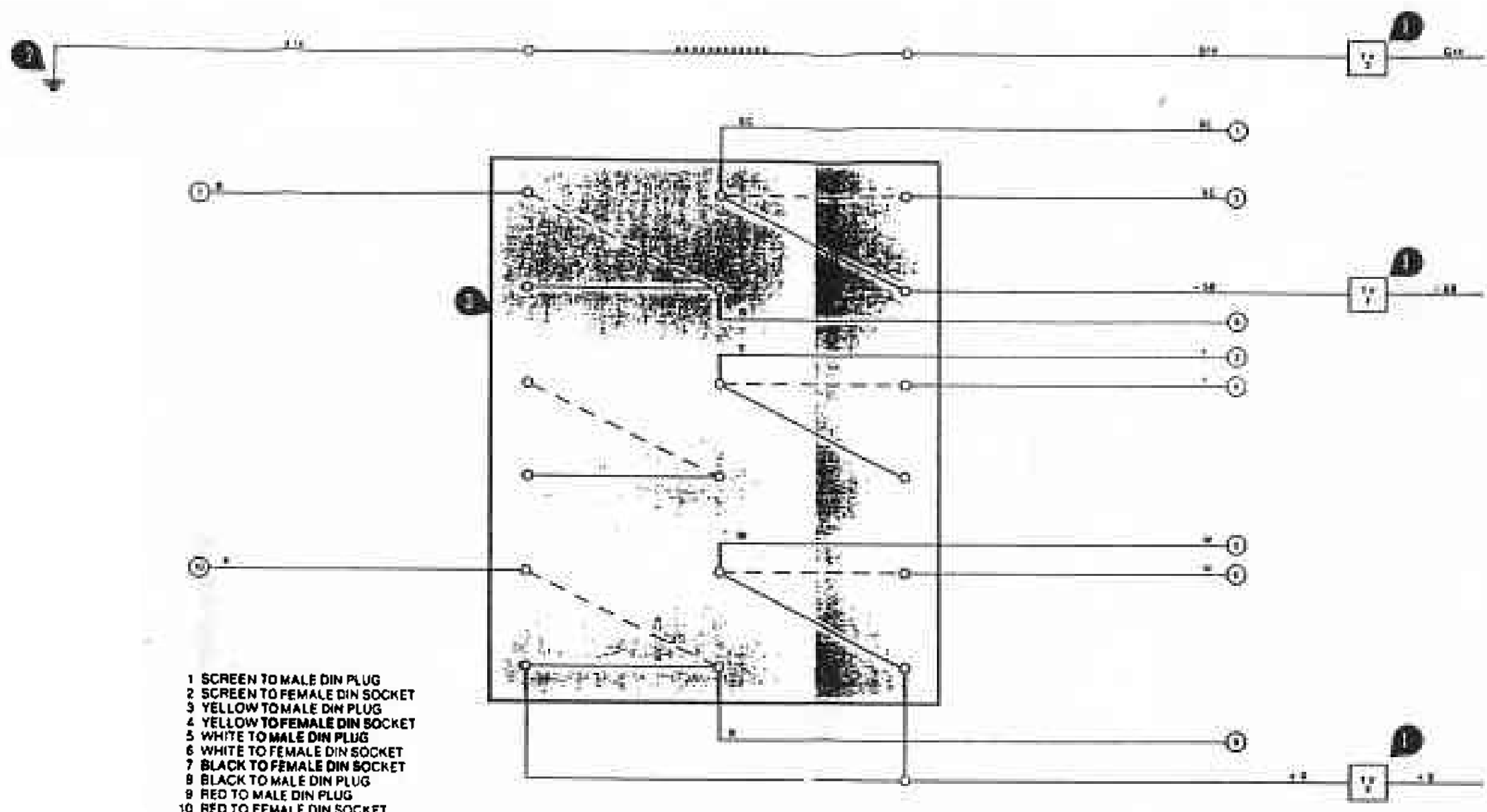

- 1 SCREEN TO MALE DIN PLUG
- 2 SCREEN TO FEMALE DIN SOCKET
- 3 YELLOW TO MALE DIN PLUG
- 4 YELLOW TO FEMALE DIN SOCKET
- 5 WHITE TO MALE DIN PLUG
- 6 WHITE TO FEMALE DIN SOCKET
- 7 BLACK TO FEMALE DIN SOCKET
- 8 BLACK TO MALE DIN PLUG
- 9 RED TO MALE DIN PLUG
- 10 RED TO FEMALE DIN SOCKET

## **Video Monitor**

Silver Spur limousine

Component location

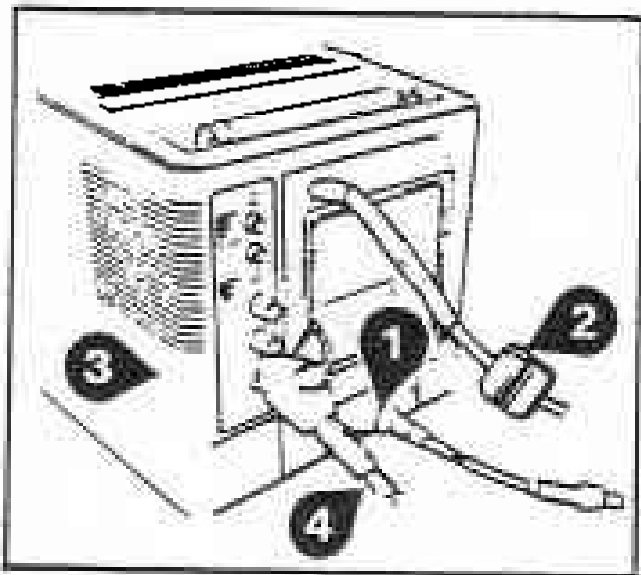
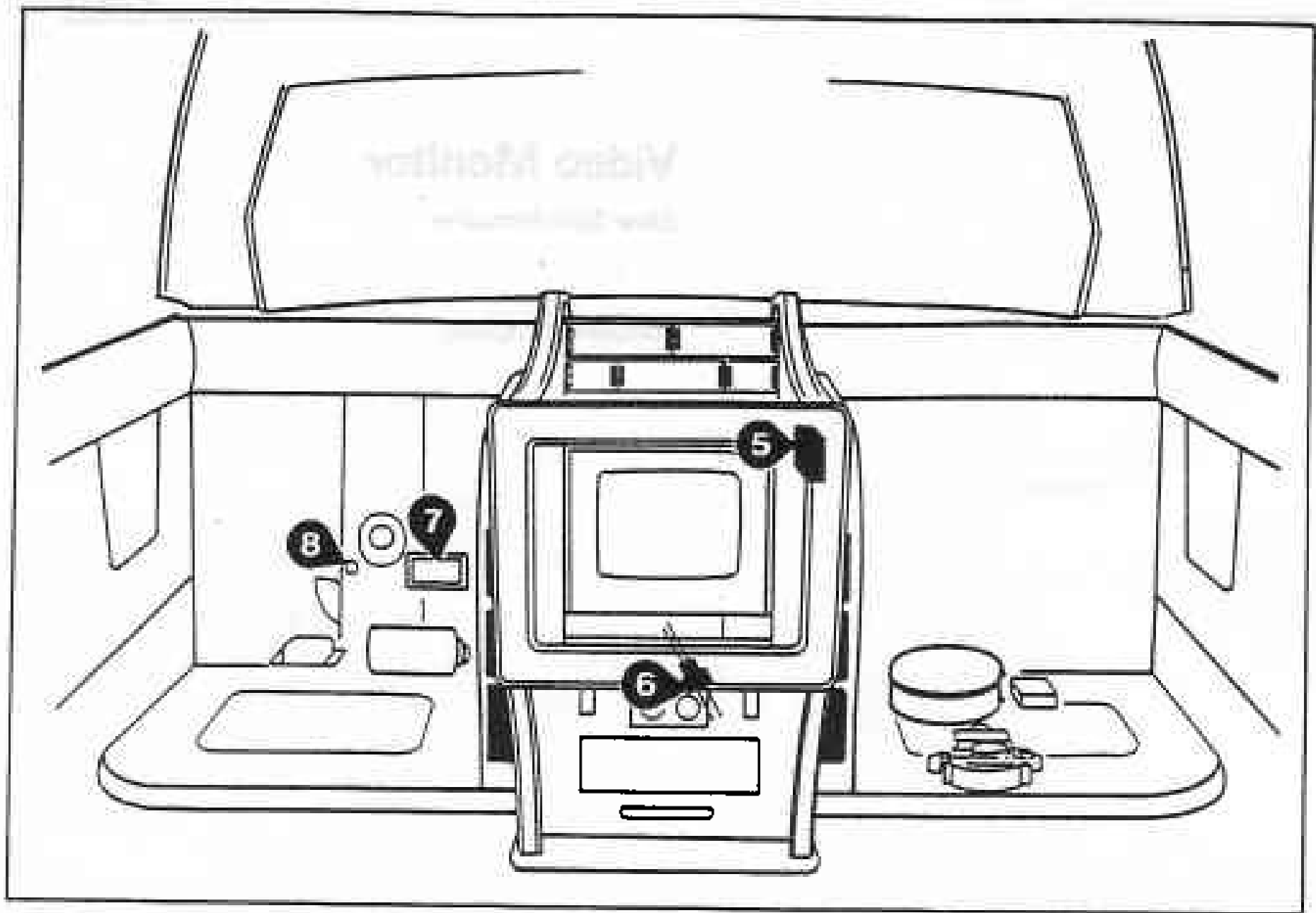

## **Video Monitor**

**Silver Spur limousine**

**Wiring diagram**

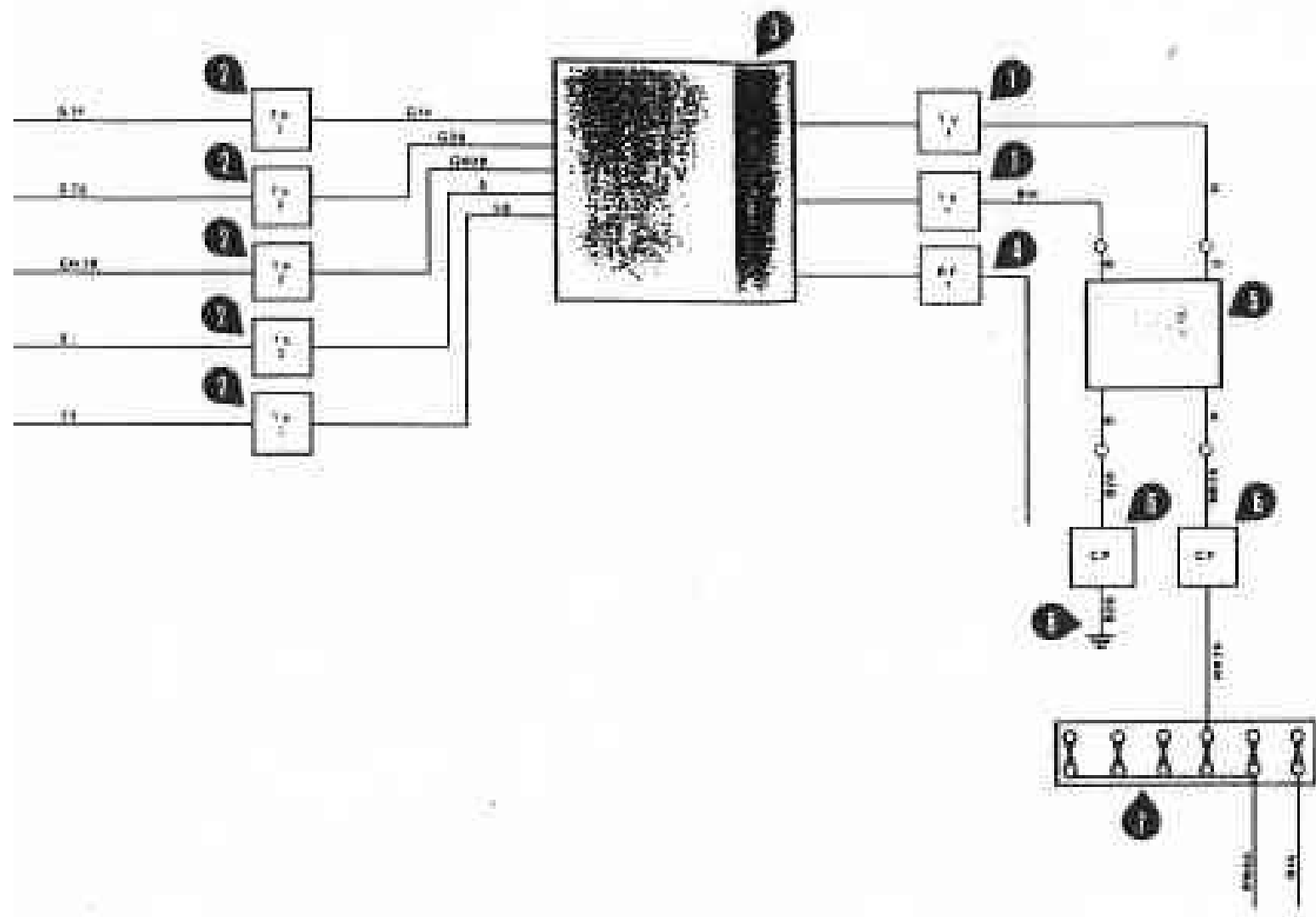

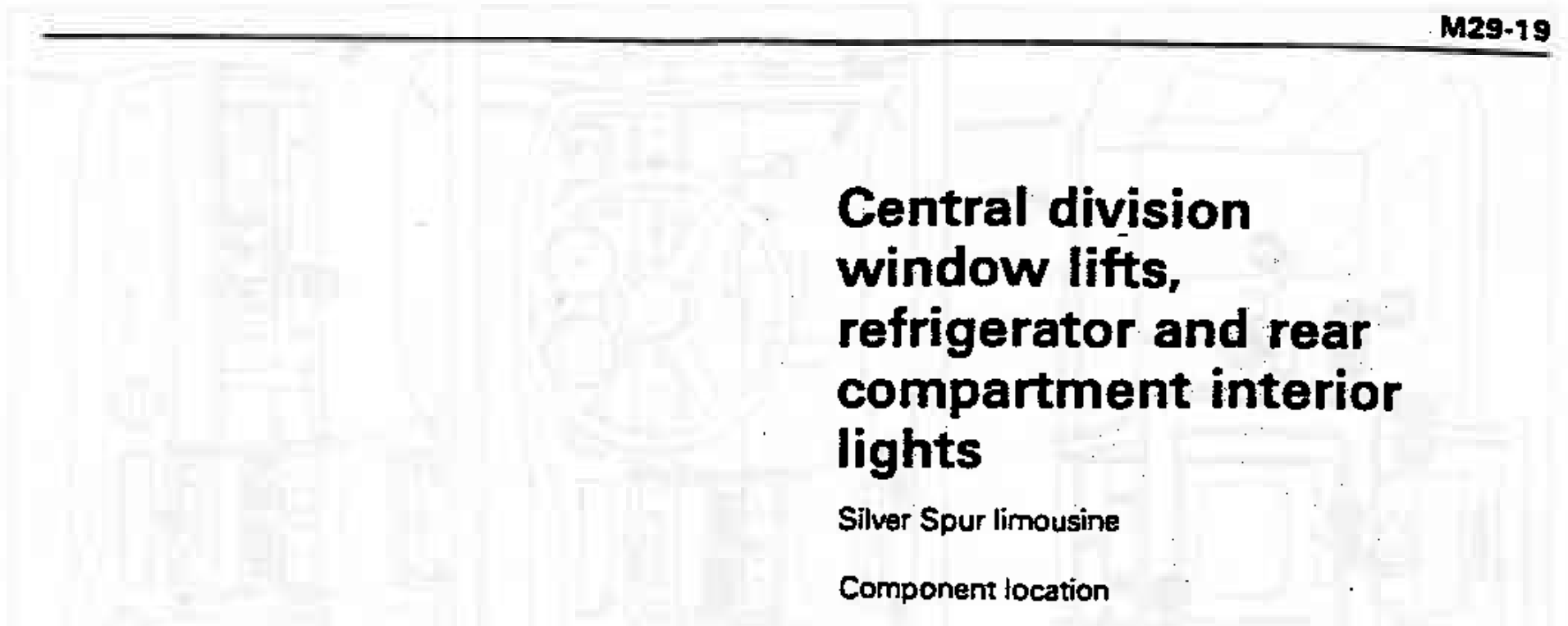



**Central division  
window lifts,  
refrigerator and rear  
compartment interior  
lights**

Silver Spur limousine

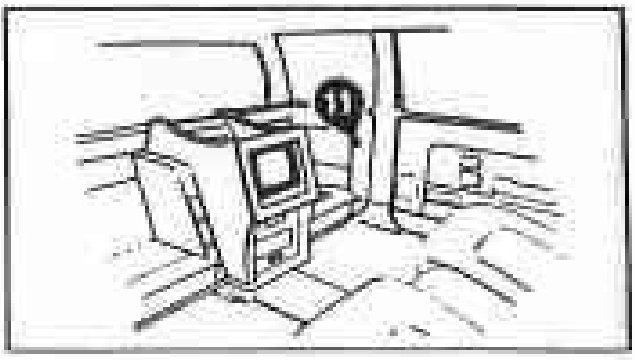
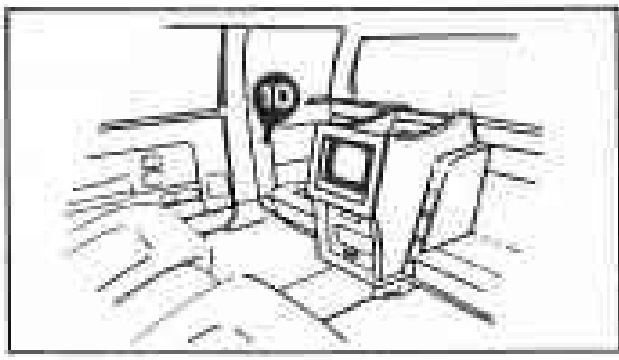
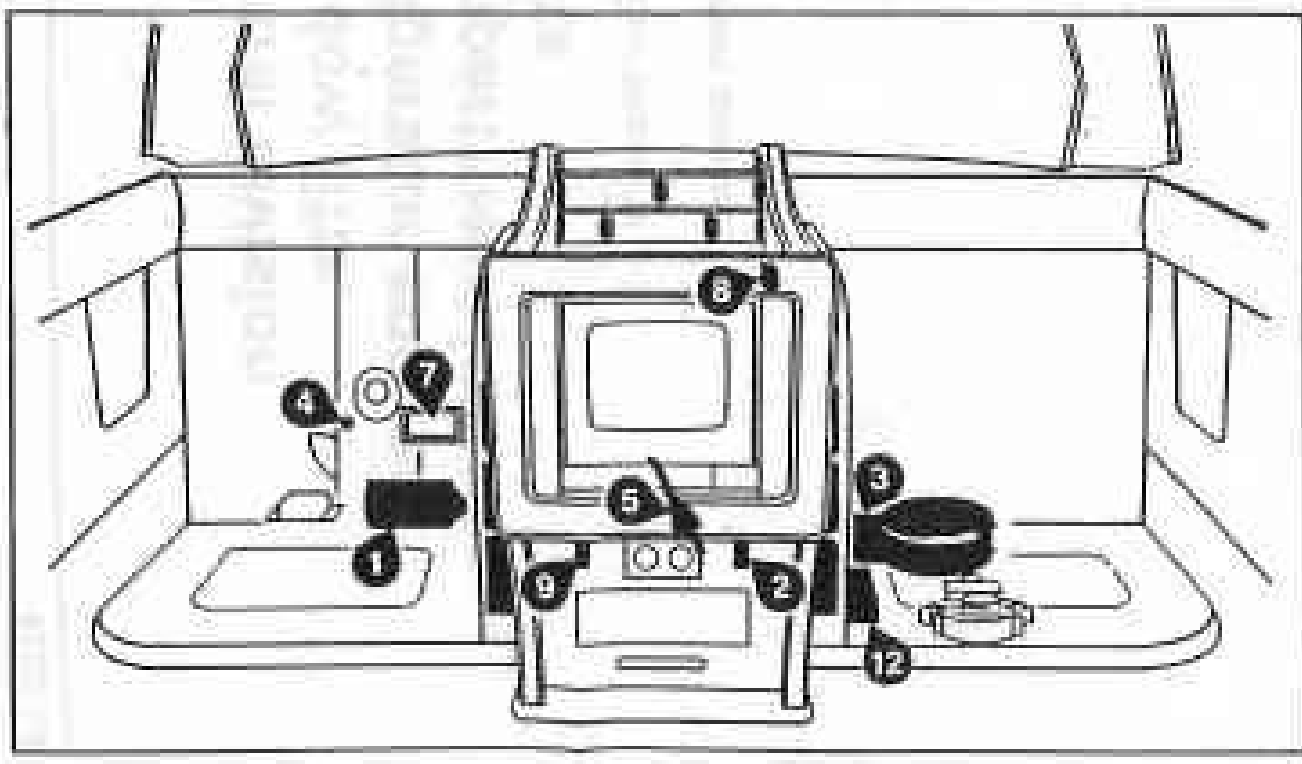
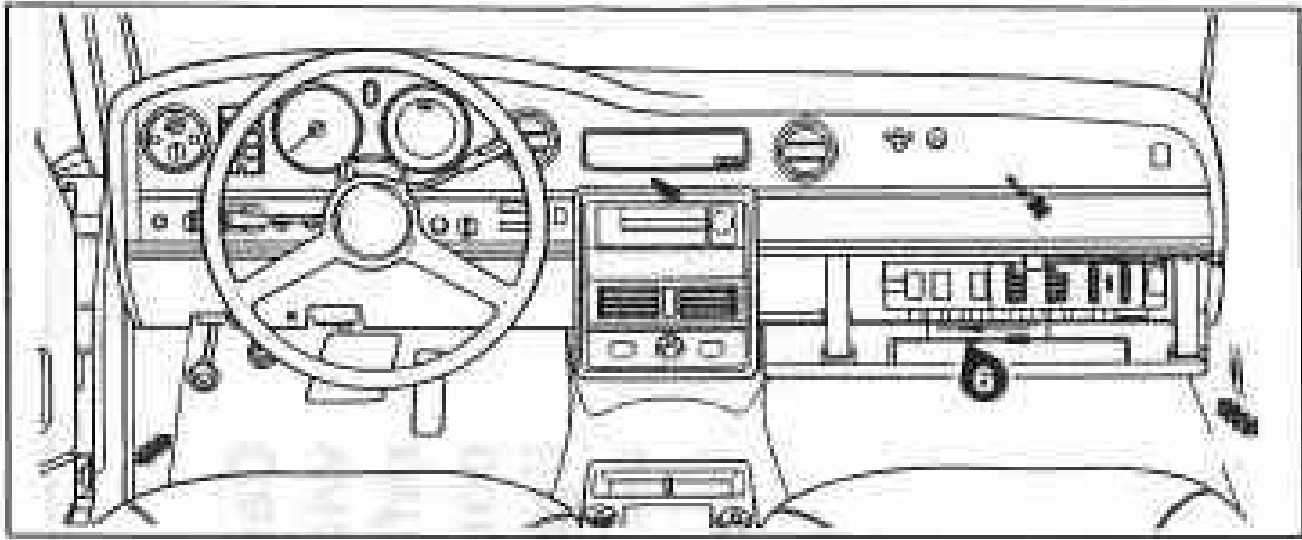
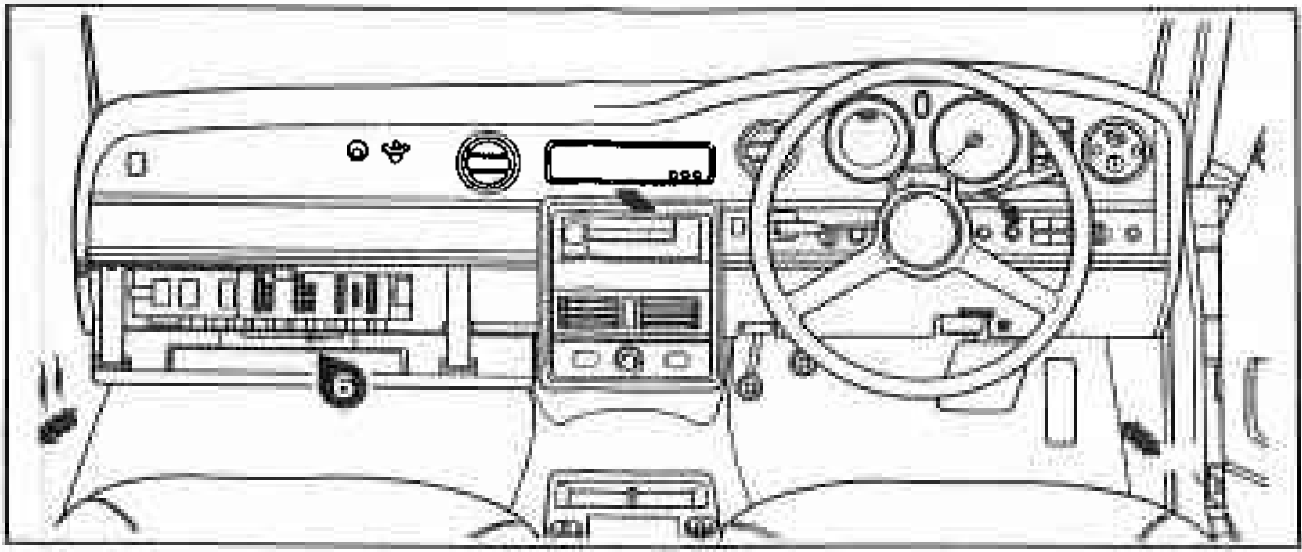
Component location





## Central division window lifts, refrigerator and rear compartment interior lights

Silver Spur limousine

Wiring diagram

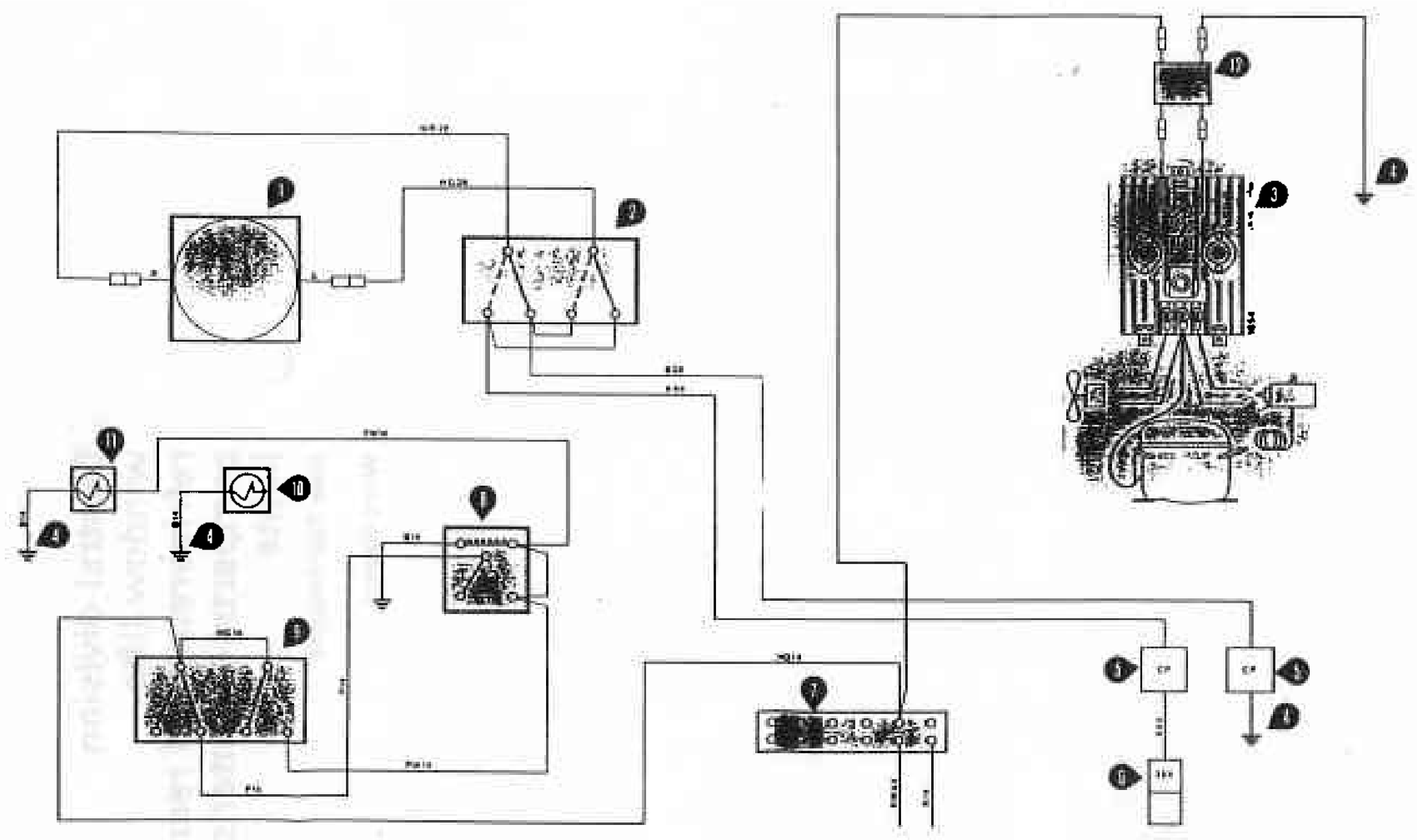

11/11/2024

Page No. 1/1

11/11/2024



## **Power distribution system**

**Silver Spur limousine rear compartment power distribution system**

**Component location**

Alternative Configuration

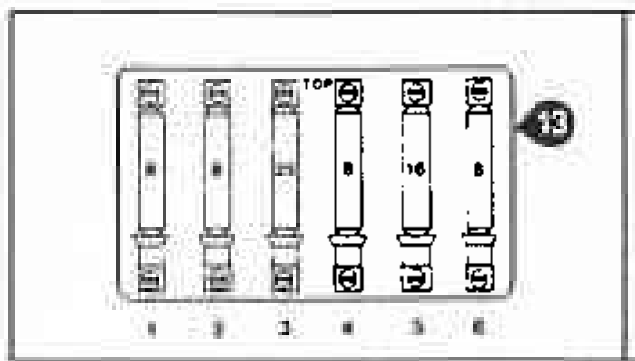
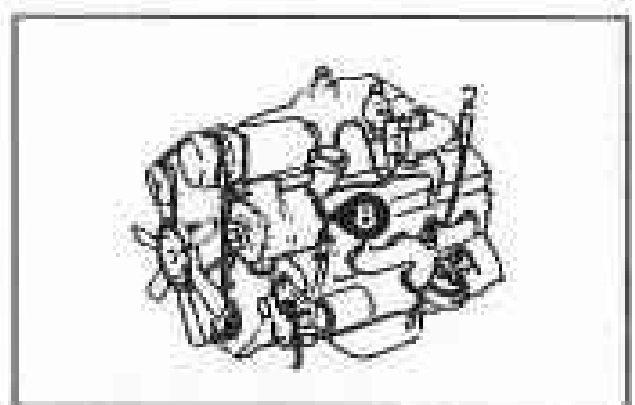
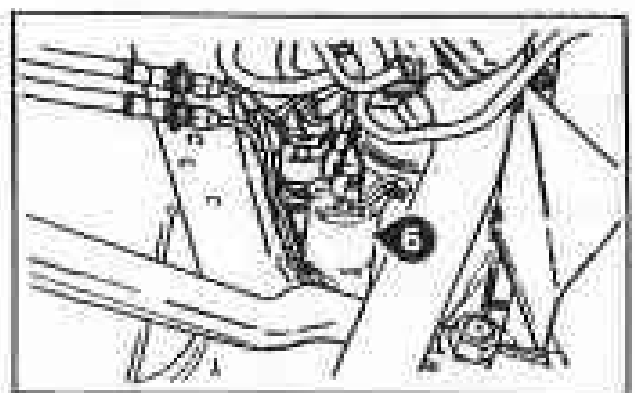
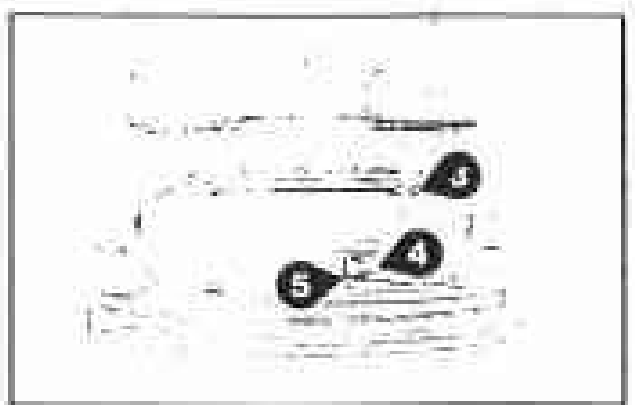
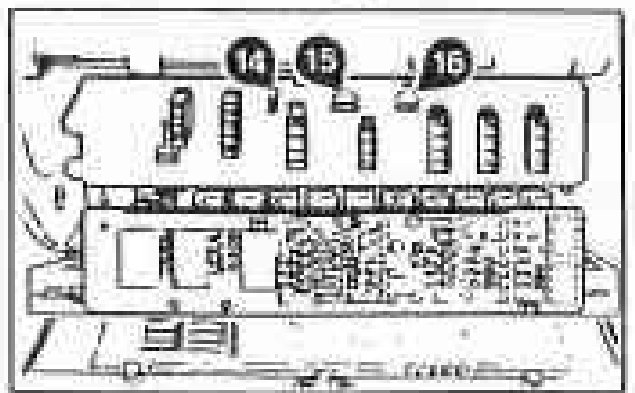
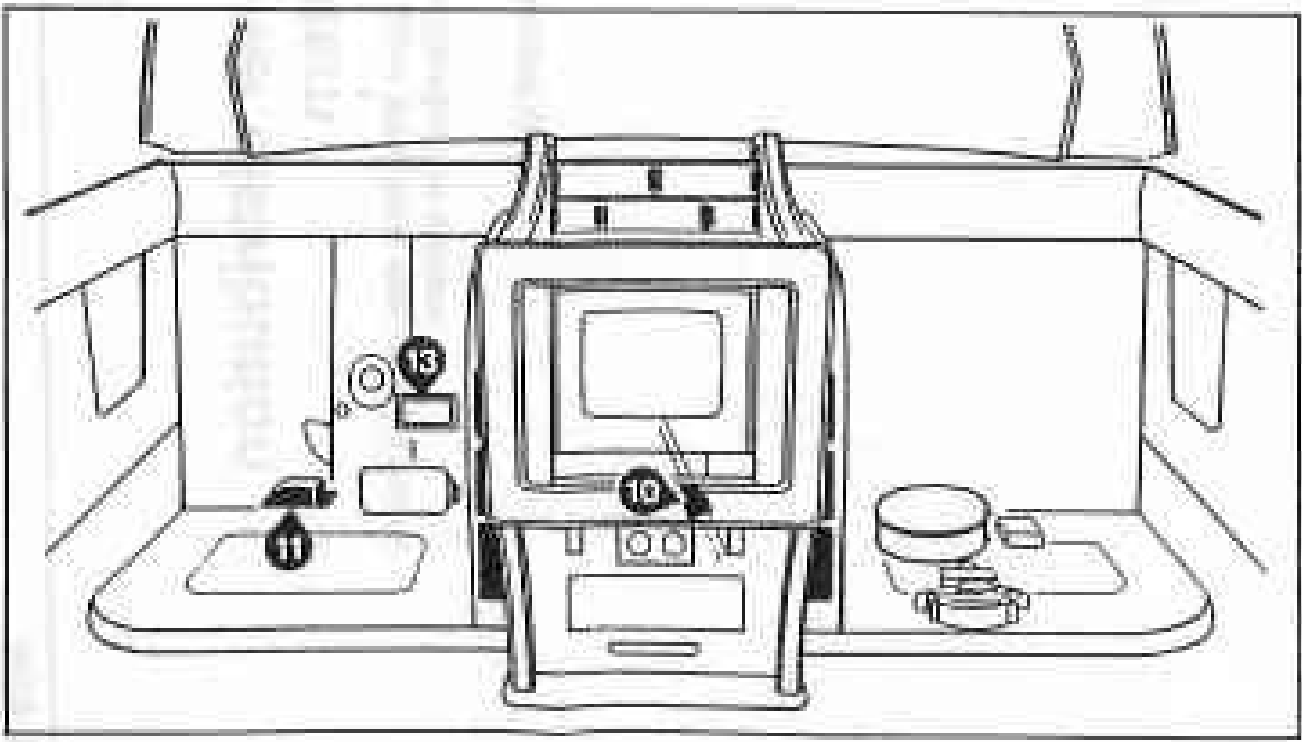
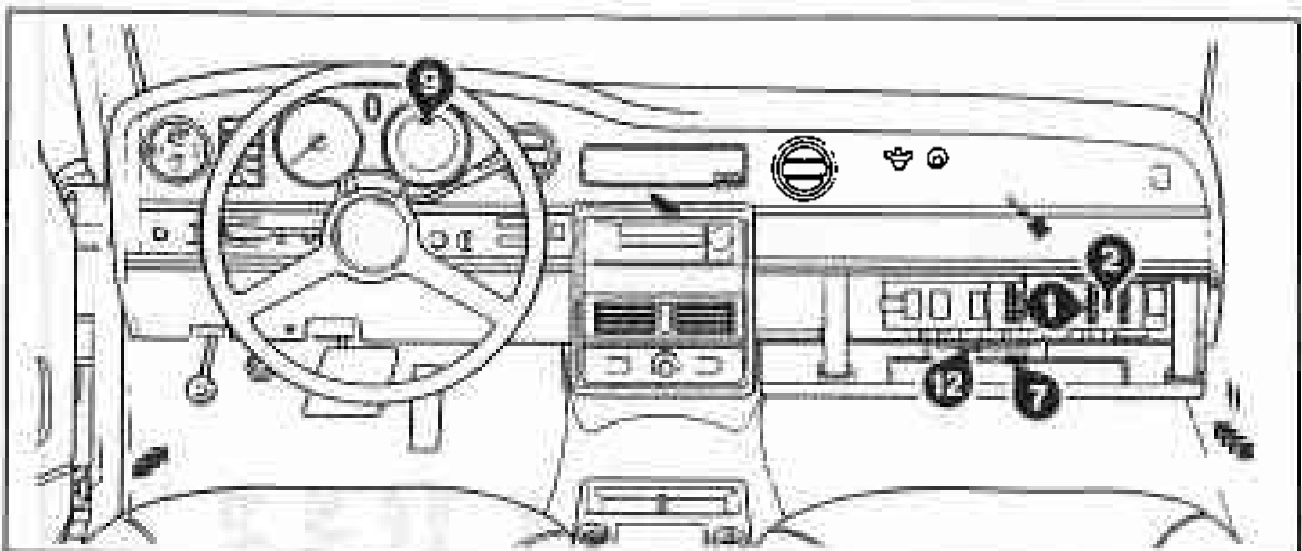
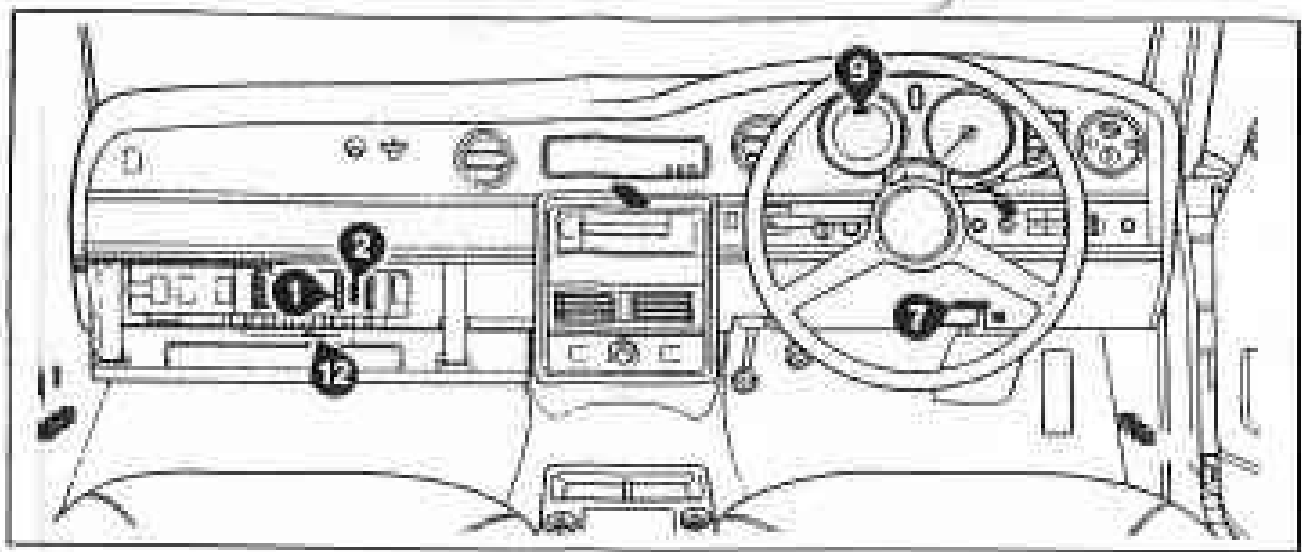

- 1 video unit
- 2 audio equipment
- 3 air conditioning fans
- 4 TV monitor
- 5 intercom and refrigeration unit
- 6 permanent feed to radio and internal lights

## **Power distribution system**

**Silver Spur limousine rear compartment power distribution system**

**Wiring diagram**

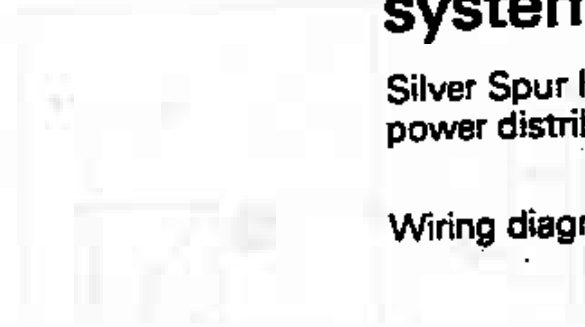



## **Rear compartment air conditioning system**

**Silver Spur limousine**

**Component location**

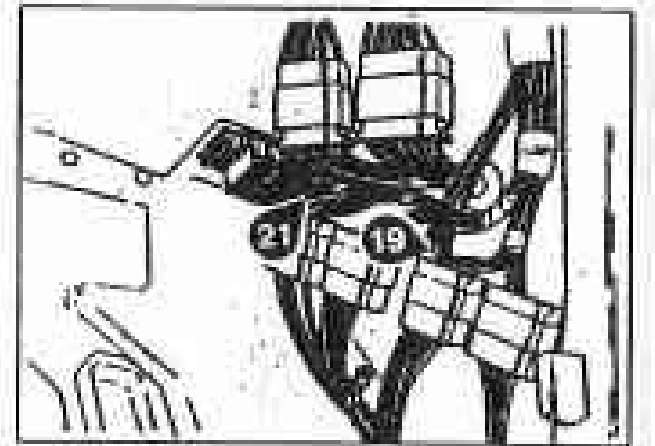
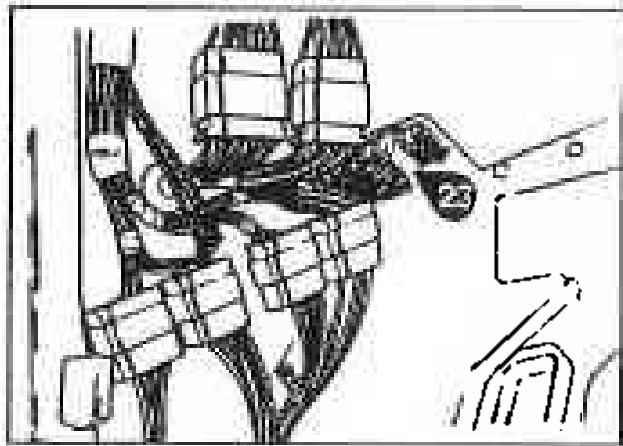
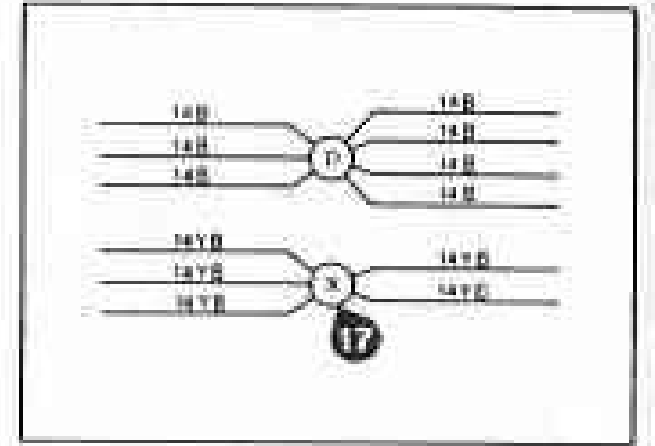
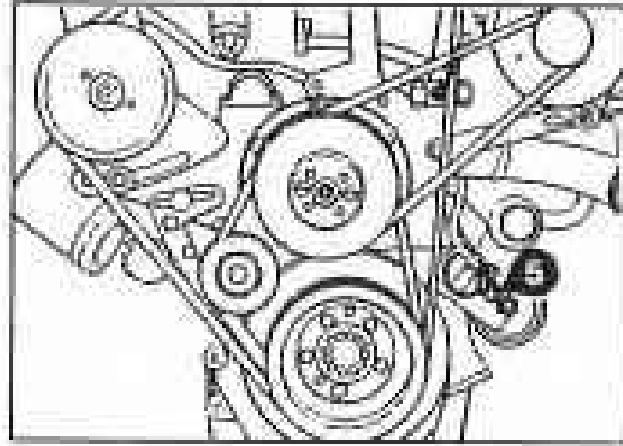
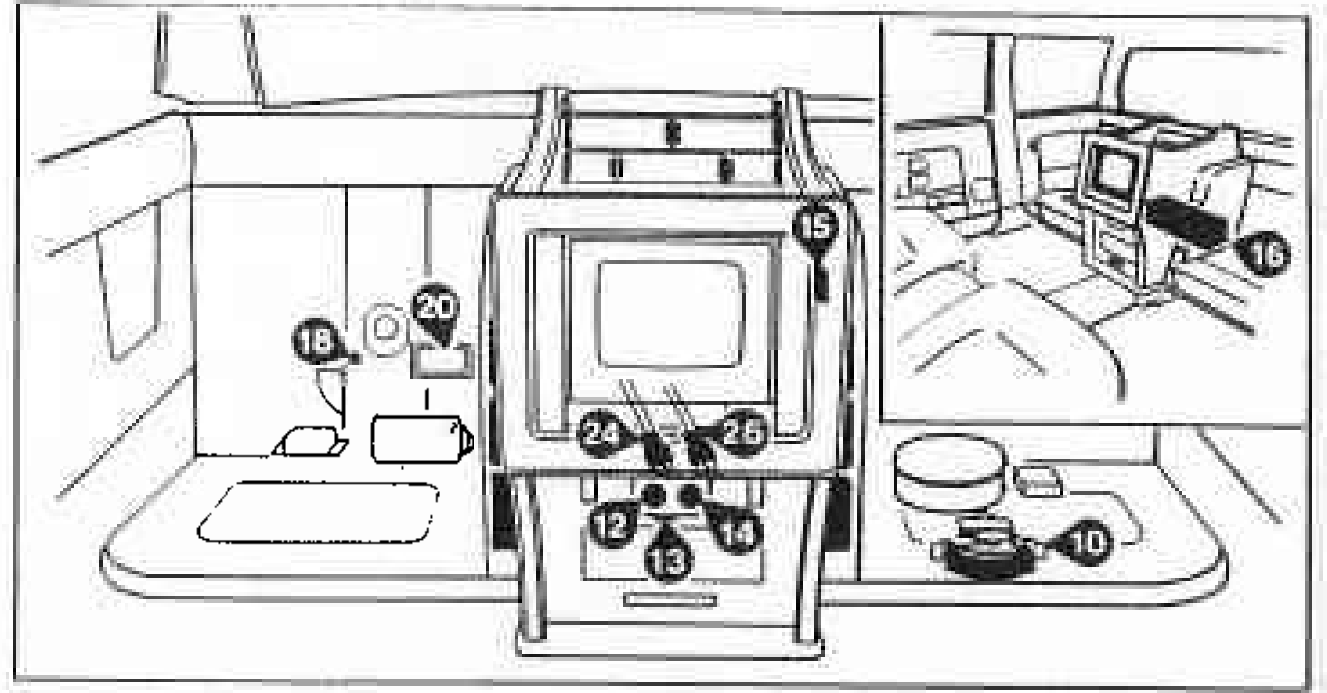
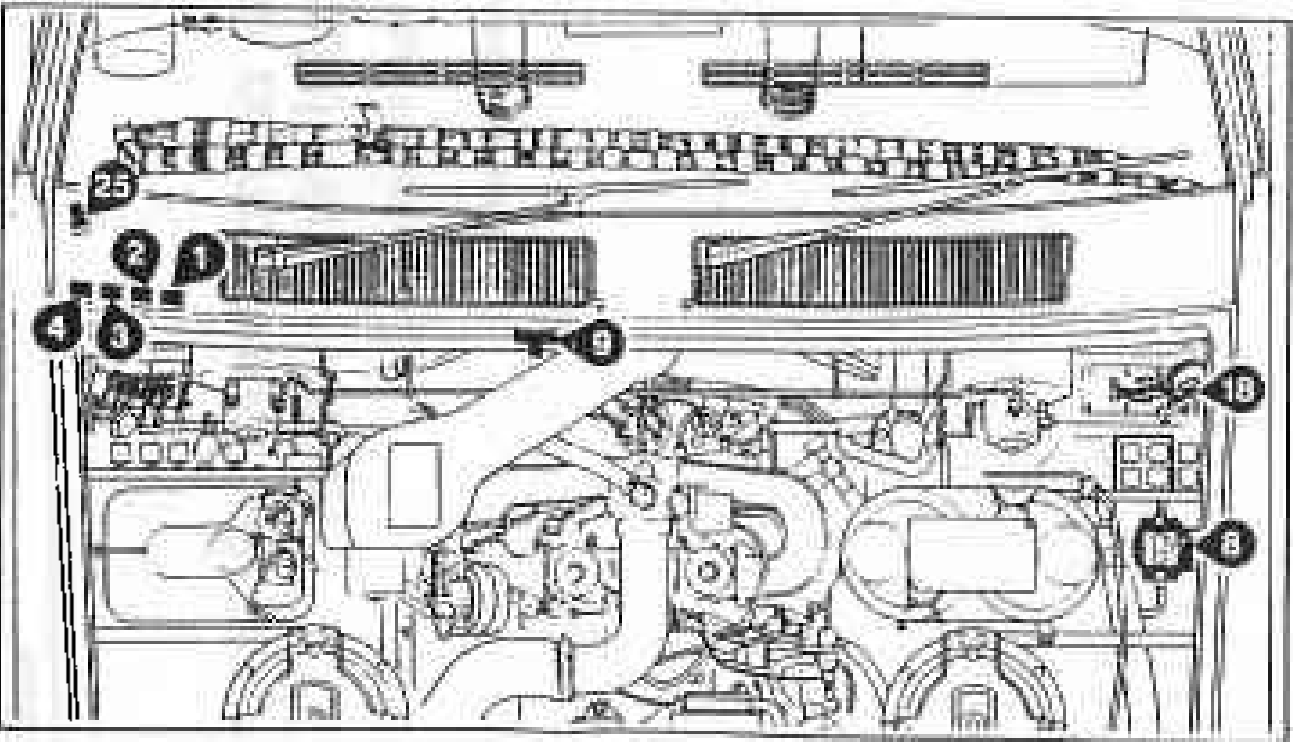
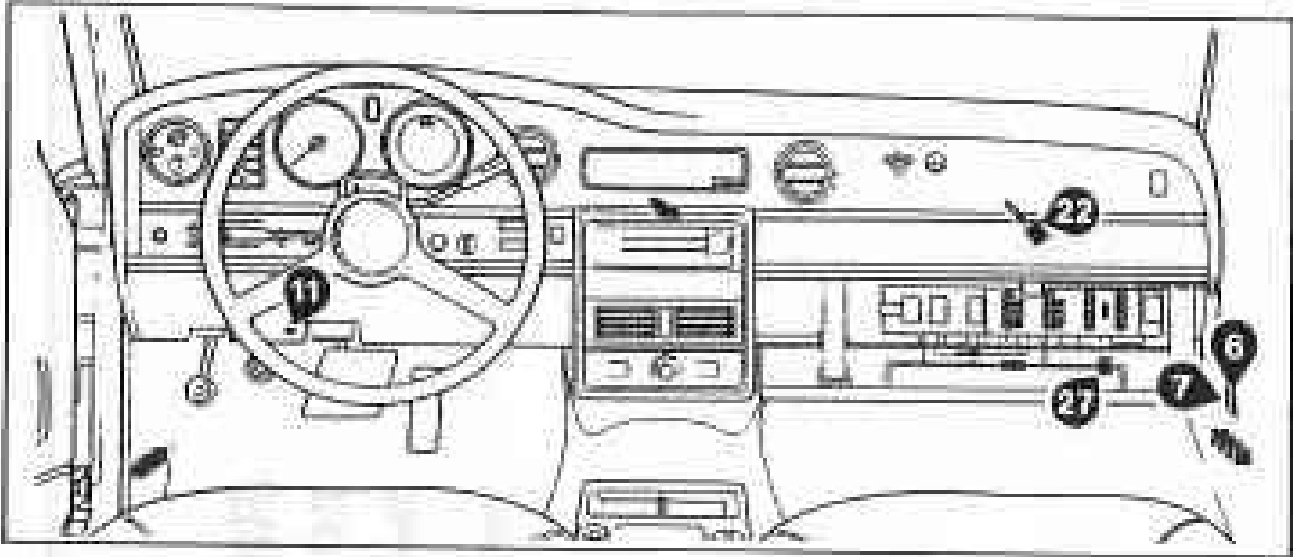
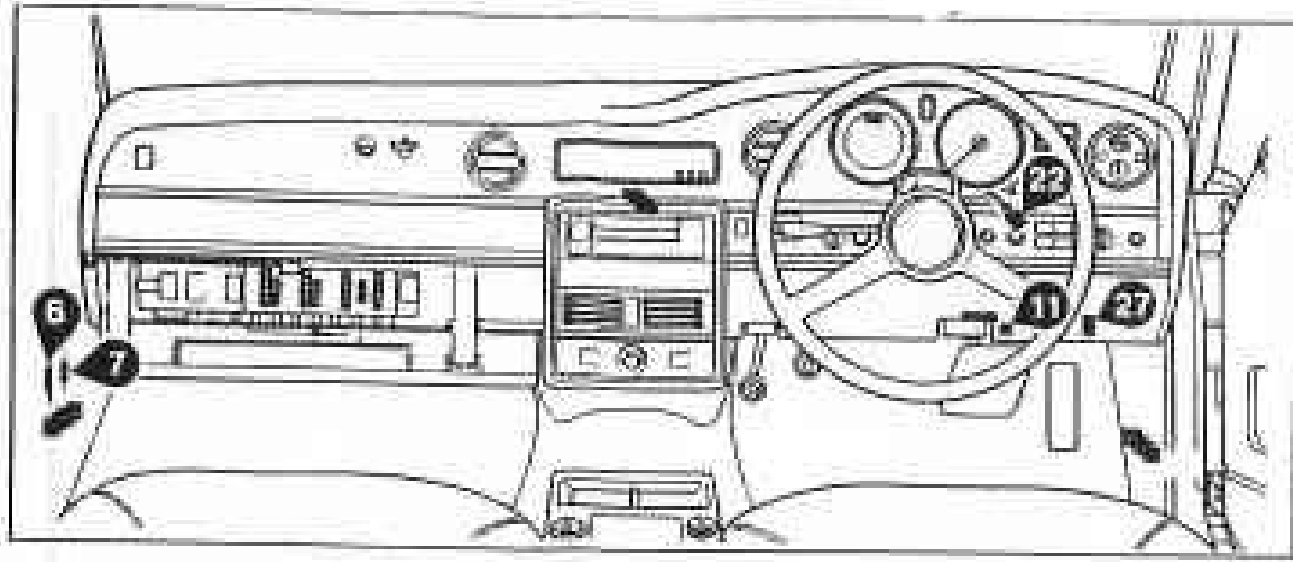

## Rear compartment air conditioning system

Silver Spur limousine

Wiring diagram

