

Fog lamps

Contents	Pages					
	Silver Spirit Mulsanne	Silver Spur	Mulsanne Turbo	Bentley Eight	Bentley Turbo R	Corniche/ Continental
Wiring diagram and component location						
<i>Cars other than those conforming to a Swiss specification</i>	M10-1	M10-1	M10-1	—	—	—
<i>Cars conforming to a Swiss specification</i>	M10-5	M10-5	M10-5	—	—	—

From VIN *SCAZS0006GCX13860* (excluding Corniche/Continental) and with the exception of VIN *SCAZN0004FCH14000* to VIN *SCAZN0009FCH14025* inclusive, a new type of fuseboard is fitted incorporating Littell or Buss fuses (these fuses are not interchangeable with Bulgin type fuses).

Therefore when working to a wiring diagram or component location showing the earlier Bulgin type of fuse, reference must be made to the following table for its equivalent.

Circuits controlled	Bulgin fuse number	Littell or Buss fuse number and fuseboard identification	Fuse rating (amps)	Circuits controlled	Bulgin fuse number	Littell or Buss fuse number and fuseboard identification	Fuse rating (amps)
Cellular telephone when fitted	—	A1 - F2	4A	Rear window demister and mirror heaters	11	B4 - F3	20A
Cellular telephone when fitted	—	A2 - F2	10A	Reverse lamps, stoplamps, speed control, headlamp wash	10	B3 - F3	20A
Interior lamps	1	A6 - F2	10A	Direction indicators, headlamp flash, fuel door, horns control	14	B2 - F3	20A
Radio, panel illumination, ACU control	20	B1 - F2	10A	Cigar lighters, clock, aerial, fuel door	7	C4 - F3	20A
Radio amplifier when fitted	19	B2 - F2	10A	Engine cooling fan	2	C1 - F3	20A
Starter, ignition, fuel pump	27	B3 - F2	10A	Engine cooling fan	9	C1 - F3	20A
Instruments and warning lamps	28	B4 - F2	10A	Wipers and washers	5	B1 - F3	20A
ACU control	8	B5 - F2	10A	Spare	—	B6 - F3	20A
Spare	—	B6 - F2	10A	Fuel pump	13	B5 - F3	20A
L.H. Tail lamp	15	C1 - F2	10A	Horns	3	C3 - F3	20A
R.H. Tail lamp	22	C2 - F2	10A	Fog lamps when fitted	12	C6 - F3	20A
Parking lamps, number plate lamps, W.L dim control	16	C3 - F2	10A	Air horns when fitted	4	C5 - F3	20A
L.H. Dip beam	24	C4 - F2	10A	Hazard warning	6	C2 - F3	20A
R.H. Dip beam	25	C5 - F2	10A				
Spare	—	C6 - F2	10A				
Spare	—	A6 - F3	20A				

For fuse identification refer to Section M1, General information, page M1-3.

Foglamps

Wiring diagram and component location

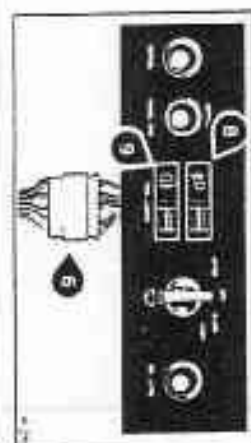
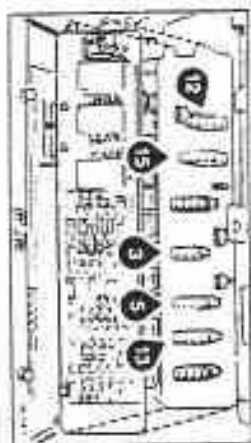
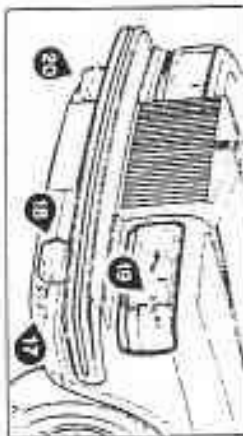
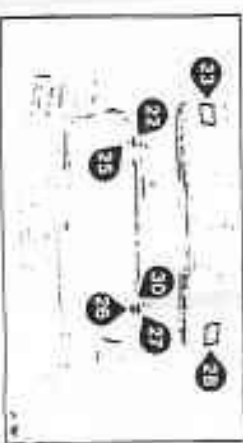
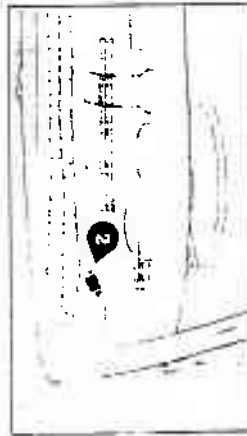
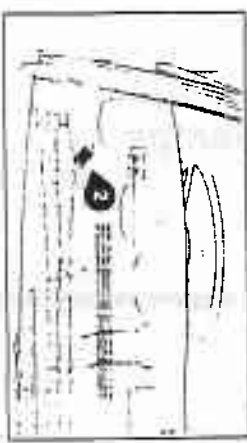
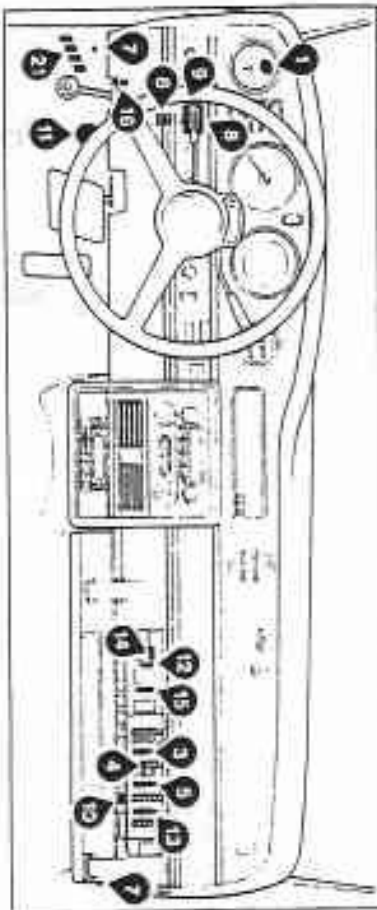
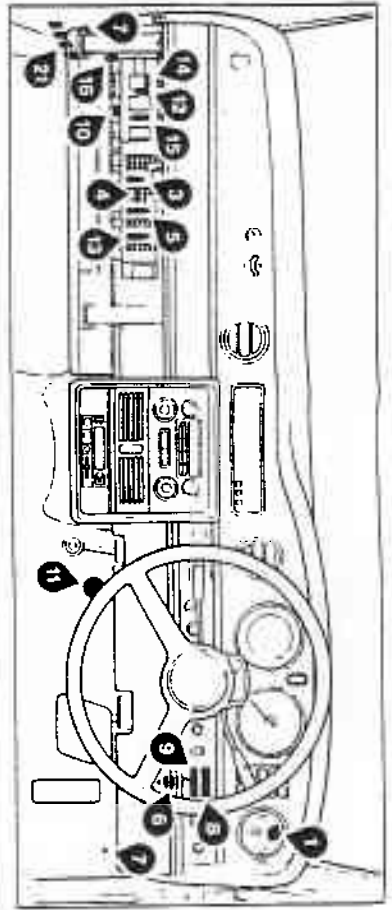

Callout	Component	Location
1	Center console	Front passenger side
2	Center console	Front passenger side
3	Center console	Front passenger side
4	Center console	Front passenger side
5	Center console	Front passenger side
6	Center console	Front passenger side
7	Center console	Front passenger side
8	Center console	Front passenger side
9	Center console	Front passenger side
10	Center console	Front passenger side
11	Center console	Front passenger side
12	Rear passenger side door handle	Rear passenger side
13	Rear passenger side door lock	Rear passenger side
14	Rear passenger side door trim	Rear passenger side
15	Rear passenger side door panel	Rear passenger side
16	Rear passenger side door sill	Rear passenger side
17	Rear driver side door handle	Rear driver side
18	Rear driver side door lock	Rear driver side
19	Rear driver side door trim	Rear driver side
20	Rear driver side door panel	Rear driver side
21	Rear driver side door sill	Rear driver side
22	Rear passenger side door handle	Rear passenger side
23	Rear passenger side door lock	Rear passenger side
24	Rear passenger side door trim	Rear passenger side
25	Rear passenger side door panel	Rear passenger side
26	Rear passenger side door sill	Rear passenger side
27	Rear passenger side door latch	Rear passenger side
28	Rear passenger side door hinge	Rear passenger side
29	Rear passenger side door latch	Rear passenger side

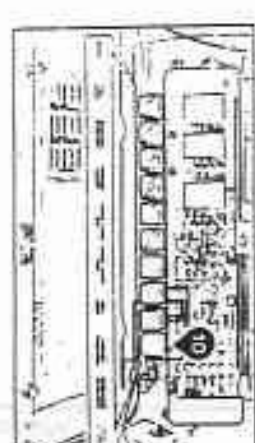
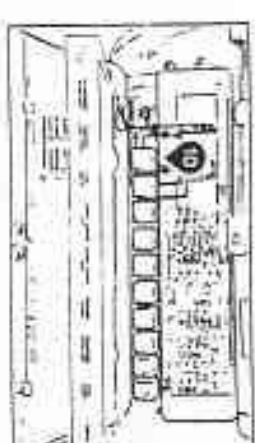
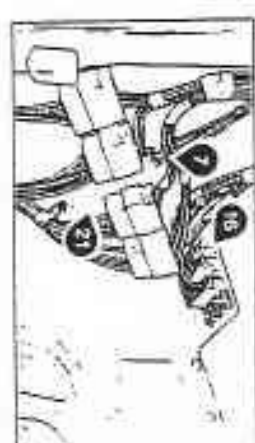

Foglamps

Wiring diagram and component location

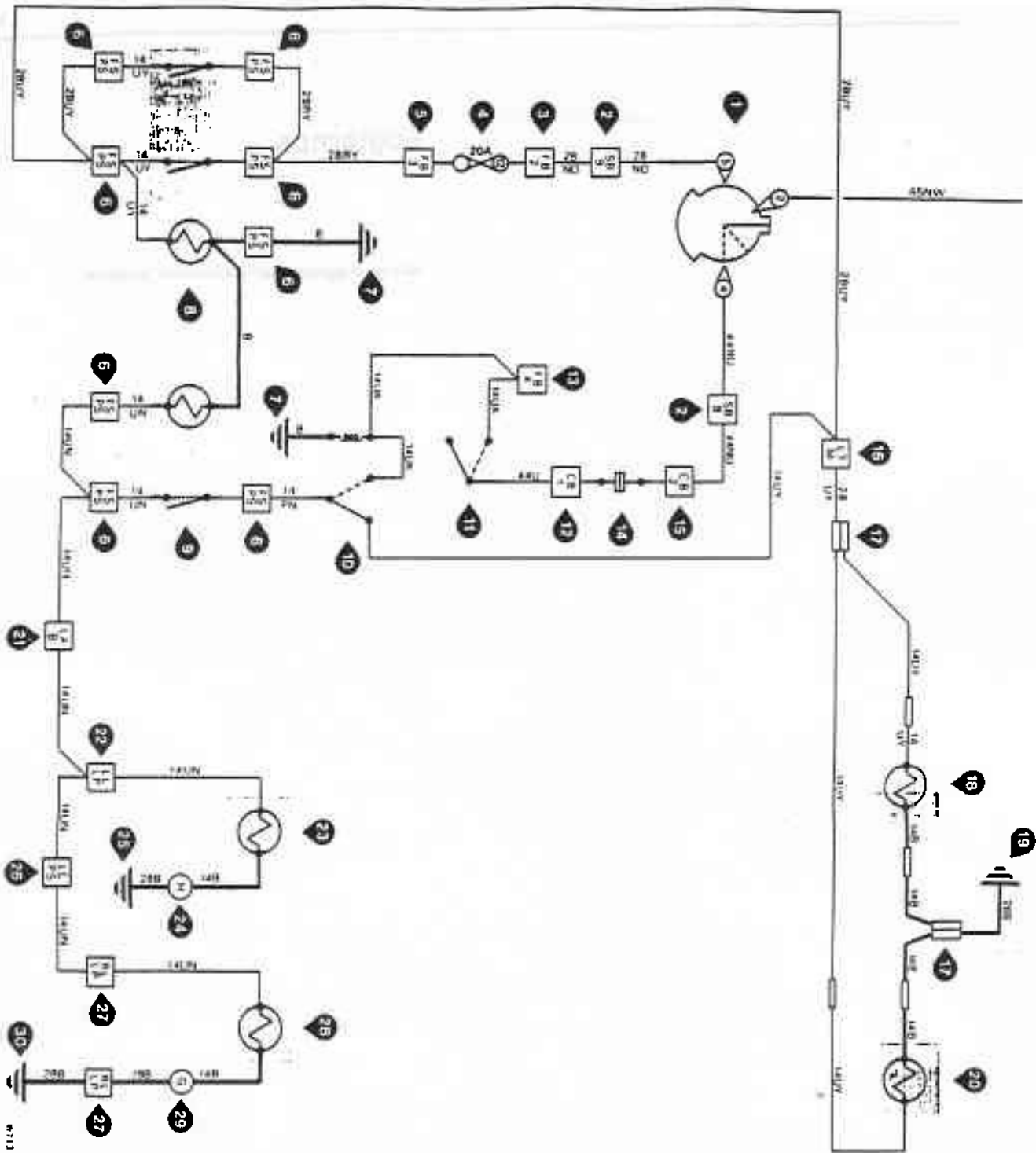

4713

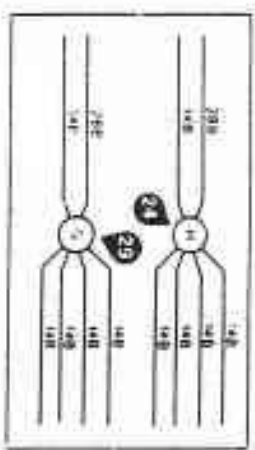
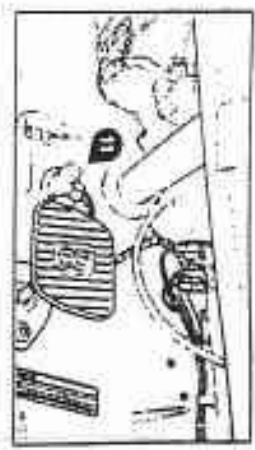

Foglamps

Cars conforming to a Swiss specification

Wiring diagram and component location

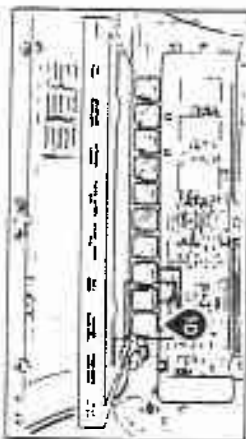
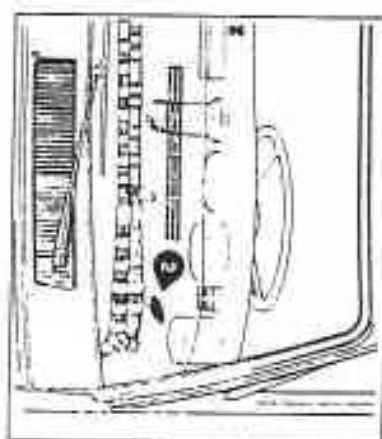
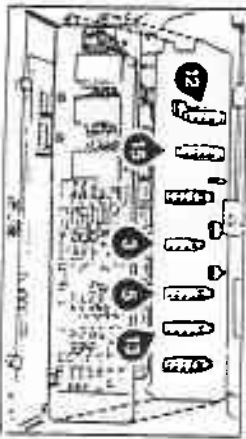
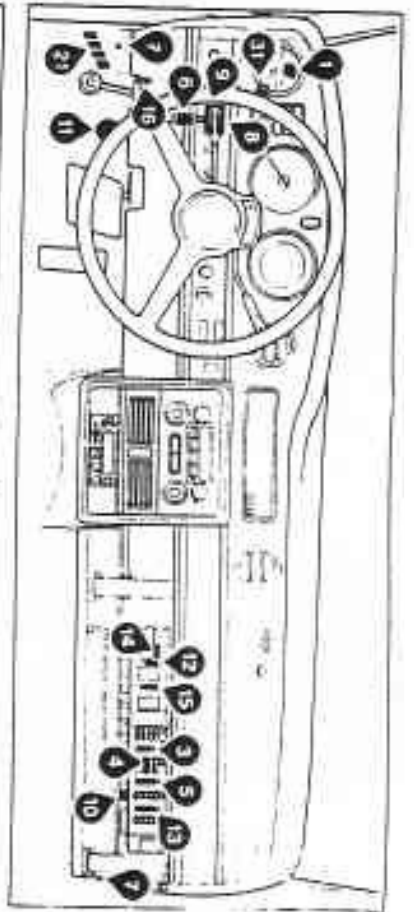
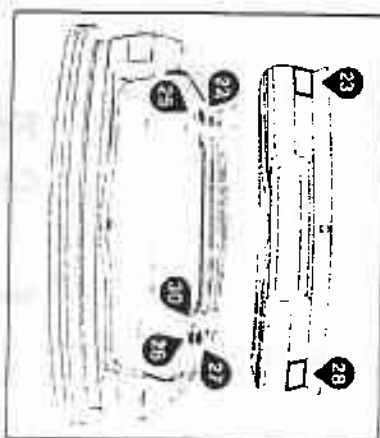
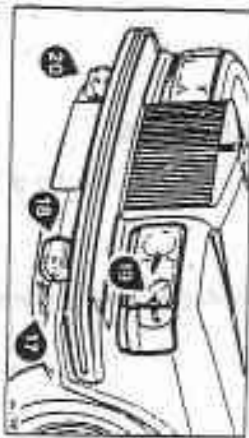

16

16-1	16-2	16-3	16-4
16-5	16-6	16-7	16-8
16-9	16-10	16-11	16-12
16-13	16-14	16-15	16-16
16-17	16-18	16-19	16-20
16-21	16-22	16-23	16-24
16-25	16-26	16-27	16-28
16-29	16-30	16-31	16-32
16-33	16-34	16-35	16-36
16-37	16-38	16-39	16-40
16-41	16-42	16-43	16-44
16-45	16-46	16-47	16-48
16-49	16-50	16-51	16-52
16-53	16-54	16-55	16-56
16-57	16-58	16-59	16-60
16-61	16-62	16-63	16-64
16-65	16-66	16-67	16-68
16-69	16-70	16-71	16-72
16-73	16-74	16-75	16-76
16-77	16-78	16-79	16-80
16-81	16-82	16-83	16-84
16-85	16-86	16-87	16-88
16-89	16-90	16-91	16-92
16-93	16-94	16-95	16-96
16-97	16-98	16-99	16-100

4

16-101

16-102

16-103

16-104

16-105

16-106

16-107

16-108

16-109

16-110

16-111

16-112

16-113

16-114

16-115

16-116

16-117

16-118

16-119

16-120

16-121

16-122

16-123

16-124

16-125

16-126

16-127

16-128

16-129

16-130

16-131

16-132

16-133

16-134

16-135

16-136

16-137

16-138

16-139

16-140

16-141

16-142

16-143

16-144

16-145

16-146

16-147

16-148

16-149

16-150

16-151

16-152

16-153

16-154

16-155

16-156

16-157

16-158

16-159

16-160

16-161

16-162

16-163

16-164

16-165

16-166

16-167

16-168

16-169

16-170

16-171

16-172

16-173

16-174

16-175

16-176

16-177

16-178

16-179

16-180

16-181

16-182

16-183

16-184

16-185

16-186

16-187

16-188

16-189

16-190

16-191

16-192

16-193

16-194

16-195

16-196

16-197

16-198

16-199

16-200

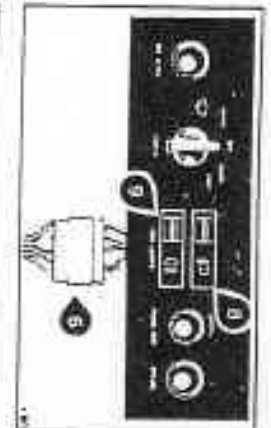

Foglamps

Cars conforming to a Swiss specification

Wiring diagram and component location

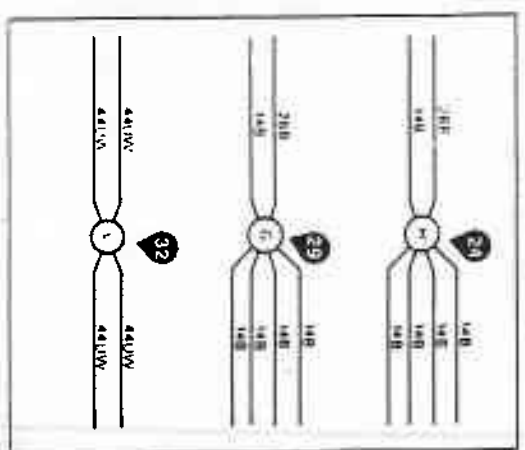
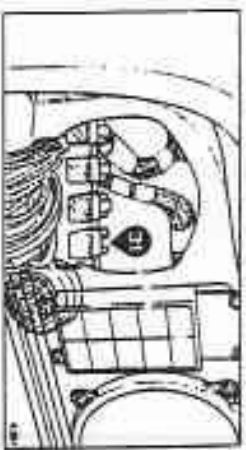
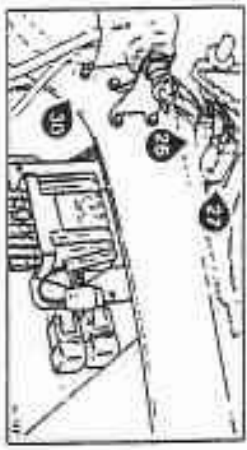
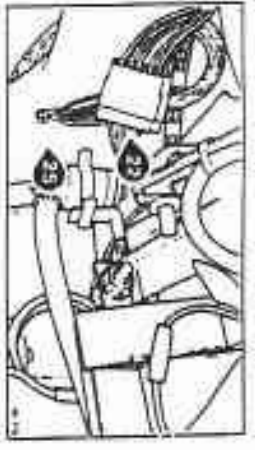
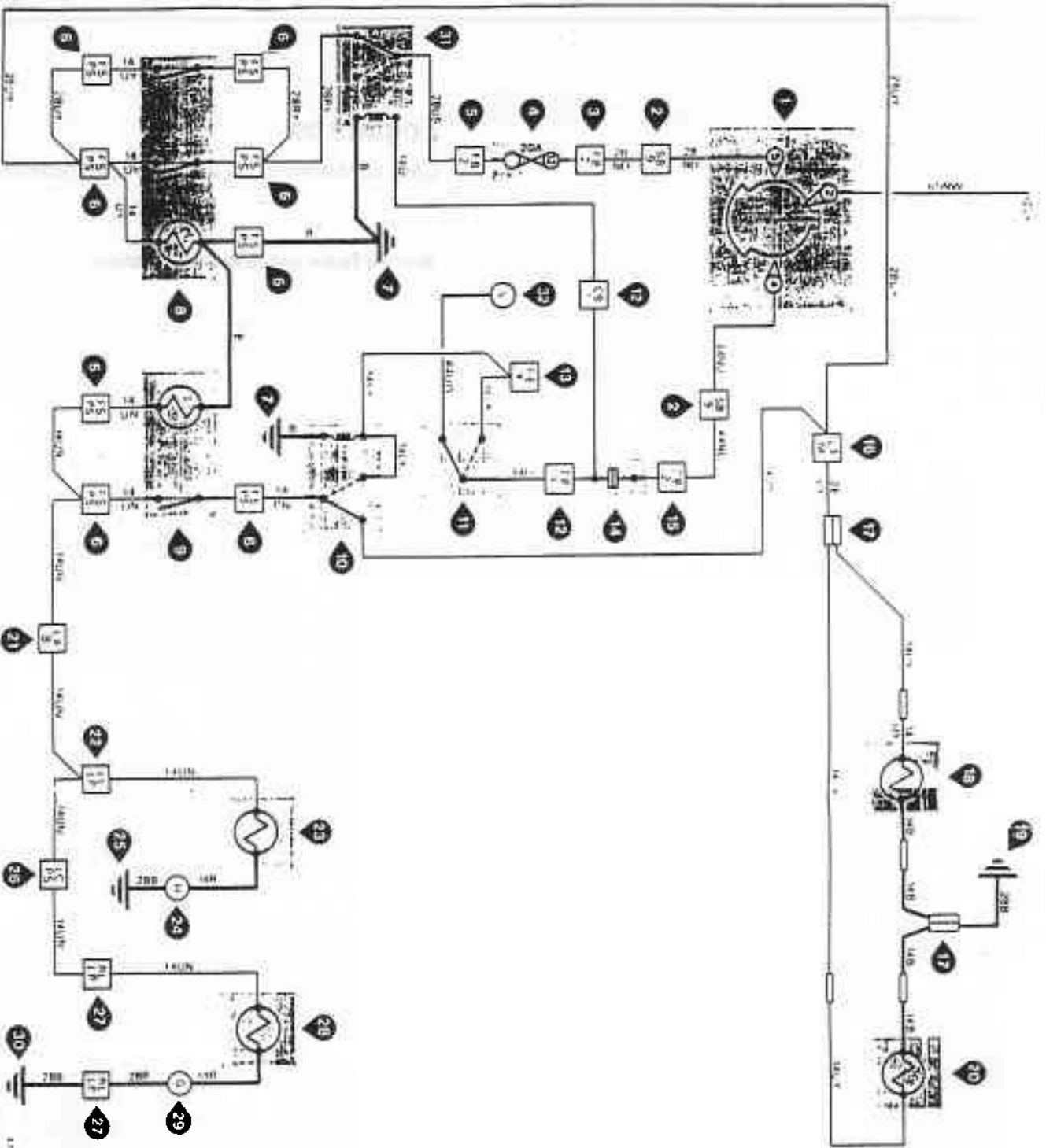

Headlamps

Contents	Pages					
	Silver Spirit Mulsanne	Silver Spur	Mulsanne Turbo	Bentley Eight	Bentley Turbo R	Corniche/ Continental
Cars prior to vehicle identification number *SCAZS42A3FCX12001*						
Component location	M11-3	M11-3	M11-3	M11-3	—	M11-3
Wiring diagram	M11-5	M11-5	M11-5	M11-5	—	M11-7
Cars from vehicle identification number *SCAZS42A3FCX12001*						
Component location	M11-9	M11-9	M11-9	M11-9	M11-9	M11-13
Wiring diagram	M11-11	M11-11	M11-11	M11-11	M11-11	M11-15

From VIN *SCAZS0006GCX13860* (excluding Corniche/Continental) and with the exception of VIN *SCAZN0004FCH14000* to VIN *SCAZN0009FCH14025* inclusive, a new type of fuseboard is fitted incorporating Littell or Buss fuses (these fuses are not interchangeable with Bulgin type fuses).

Therefore when working to a wiring diagram or component location showing the earlier Bulgin type of fuse, reference must be made to the following table for its equivalent.

Circuits controlled	Bulgin fuse number	Littell or Buss fuse number and fuseboard identification	Fuse rating (amps)	Circuits controlled	Bulgin fuse number	Littell or Buss fuse number and fuseboard identification	Fuse rating (amps)
Cellular telephone when fitted	—	A1 - F2	4A	Rear window demister and mirror heaters	11	B4 - F3	20A
Cellular telephone when fitted	—	A2 - F2	10A	Reverse lamps, stoplamps, speed control, headlamp wash	10	B3 - F3	20A
Interior lamps	1	A6 - F2	10A	Direction indicators, headlamp flash, fuel door, horns control	14	B2 - F3	20A
Radio, panel illumination, ACU control	20	B1 - F2	10A	Cigar lighters, clock, aerial, fuel door	7	C4 - F3	20A
Radio amplifier when fitted	19	B2 - F2	10A	Engine cooling fan	2	C1 - F3	20A
Starter, ignition, fuel pump	27	B3 - F2	10A	Engine cooling fan	9	C1 - F3	20A
Instruments and warning lamps	28	B4 - F2	10A	Wipers and washers	5	B1 - F3	20A
ACU control	8	B5 - F2	10A	Spare	—	B6 - F3	20A
Spare	—	B6 - F2	10A	Fuel pump	13	B5 - F3	20A
L.H. Tail lamp	15	C1 - F2	10A	Horns	3	C3 - F3	20A
R.H. Tail lamp	22	C2 - F2	10A	Fog lamps when fitted	12	C6 - F3	20A
Parking lamps, number plate lamps, W.L. dim control	16	C3 - F2	10A	Air horns when fitted	4	C5 - F3	20A
L.H. Dip beam	24	C4 - F2	10A	Hazard warning	6	C2 - F3	20A
R.H. Dip beam	25	C5 - F2	10A				
Spare	—	C6 - F2	10A				
Spare	—	A6 - F3	20A				

For fuse identification refer to Section M1, General information, page M1-3.

Headlamps

Wiring diagram and component location

Headlamps

Silver Spirit, Silver Spur, Mulsonna (including Turbo), and Corniche

Component location



Not applicable to cars conforming to a North American specification

Headlamps

Silver Spirit, Silver Spur, and Mulsanne
(including Turbo)

Wiring diagram

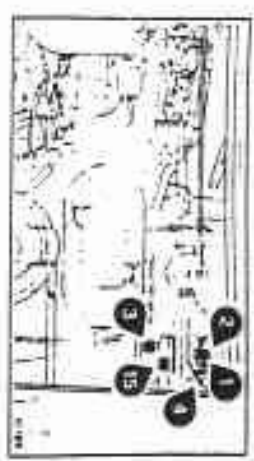
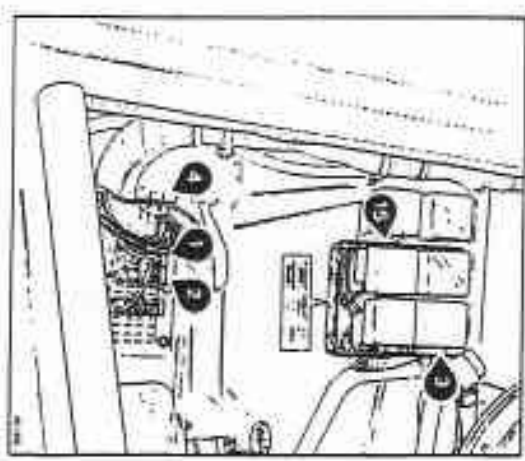
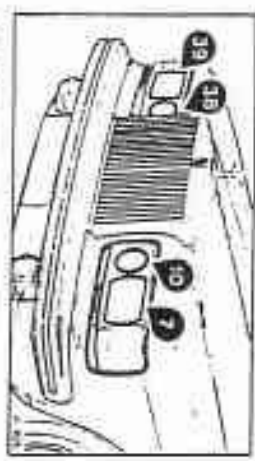
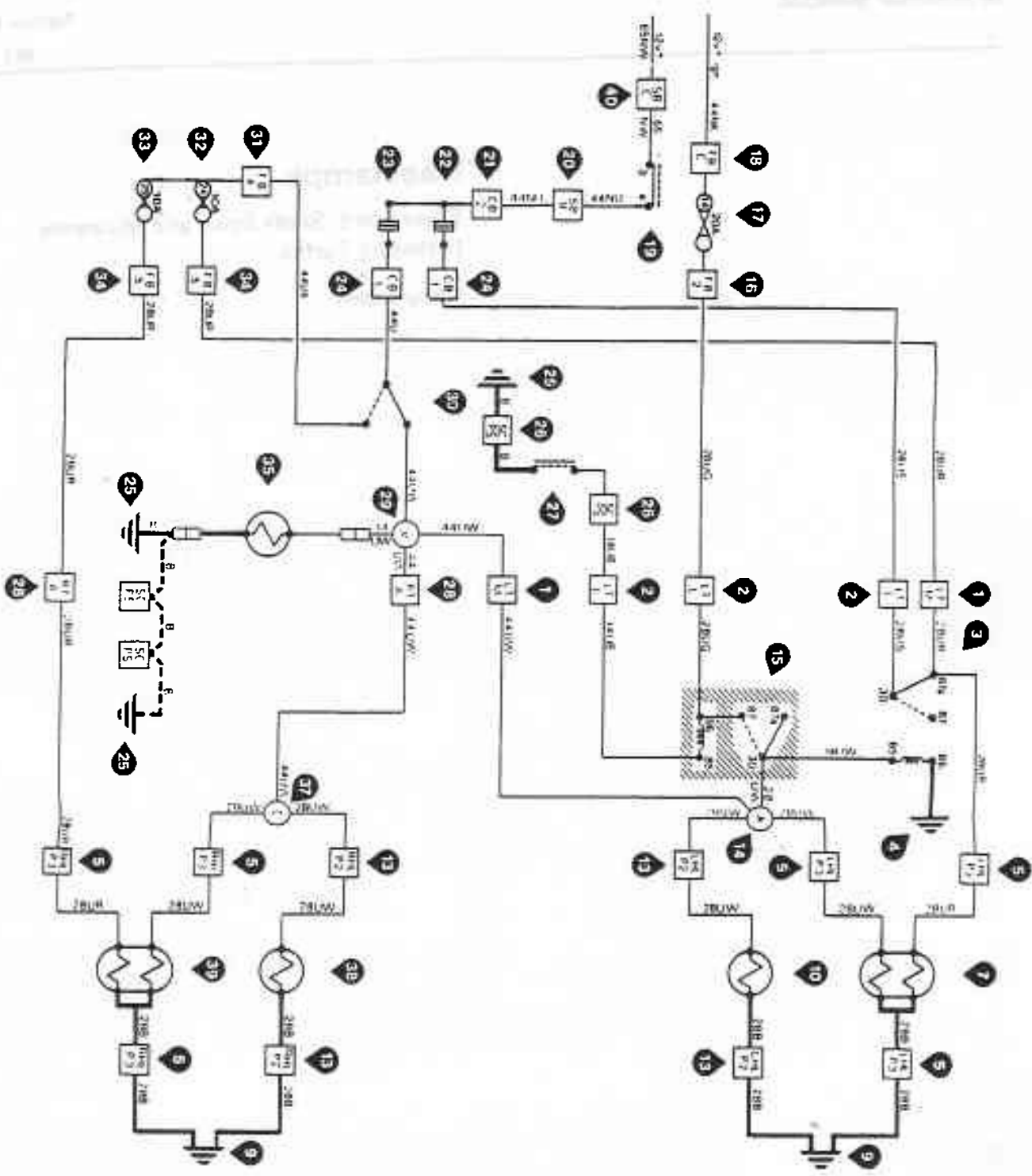

Handwritten notes at the bottom left of the page, possibly providing additional information or instructions related to the wiring diagram.

Headlamps

Comiche

Wiring diagram

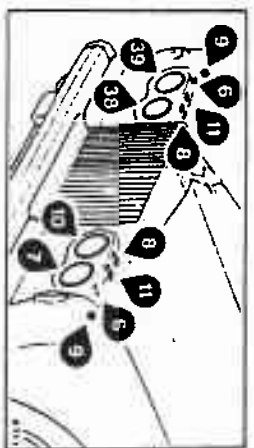
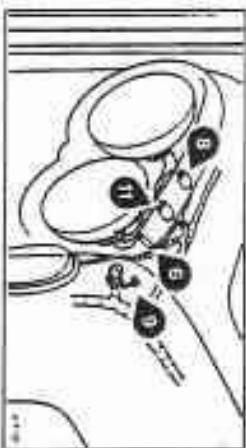
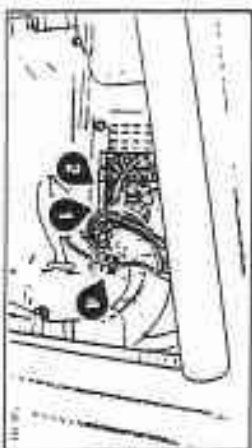
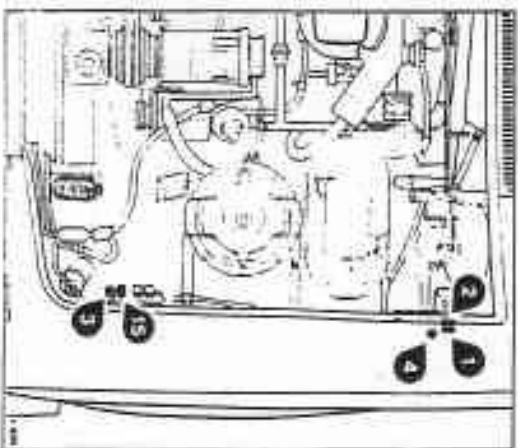
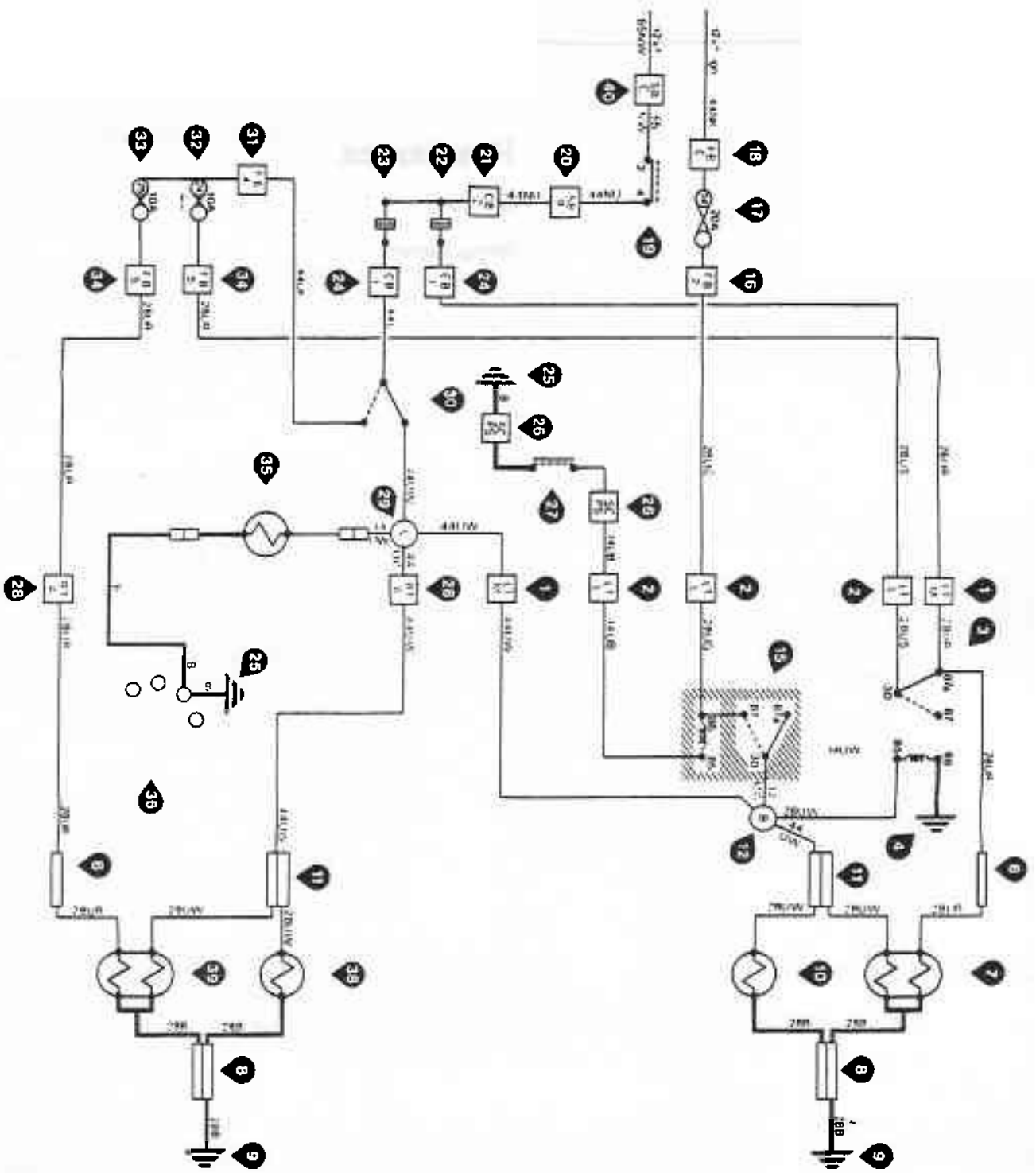

Headlamps

Silver Spirit, Silver Spur, Mulsanne (including Turbo), Bentley Eight, and Bentley Turbo R

Component location

Headlamps

Silver Spirit, Silver Spur, Mulsanne (including Turbo), Bentley Eight, and Bentley Turbo R

Wiring diagram

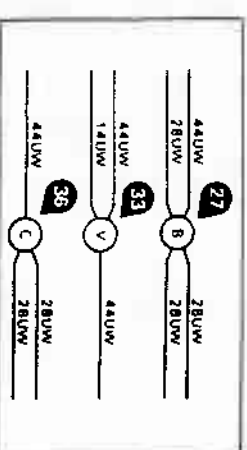
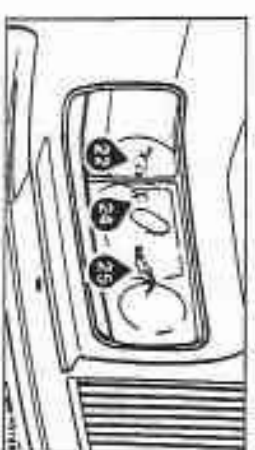
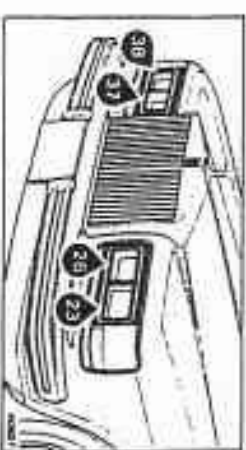
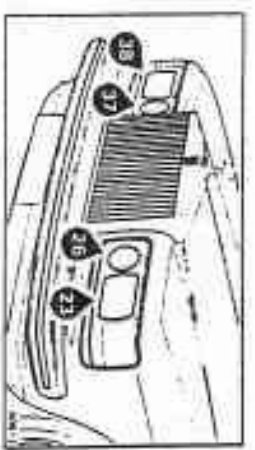
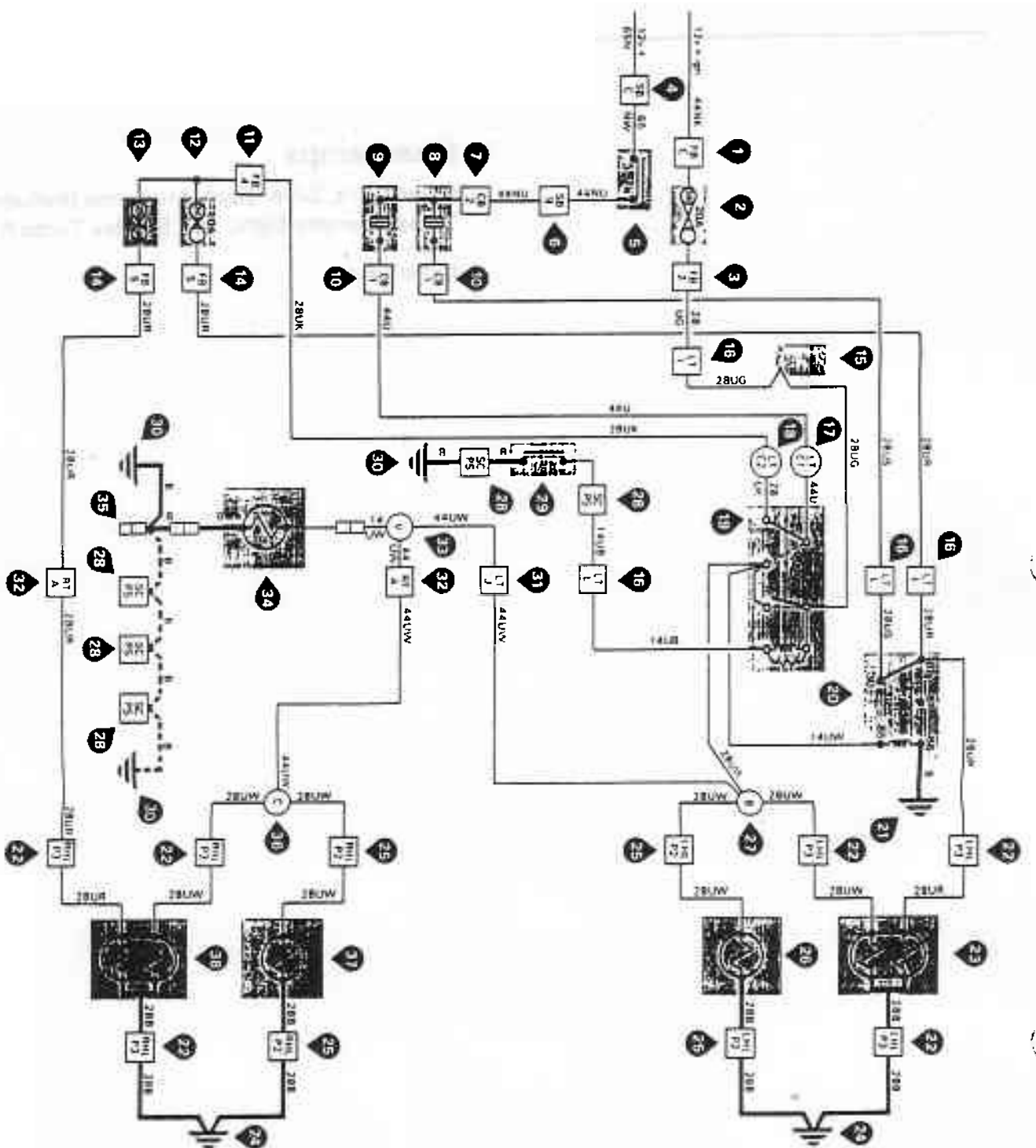

Headlamps

Corniche/Continental

Component location

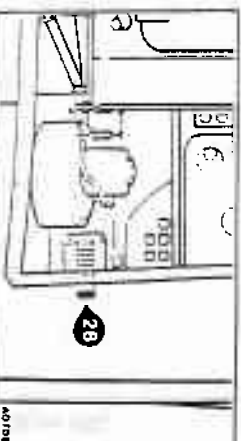
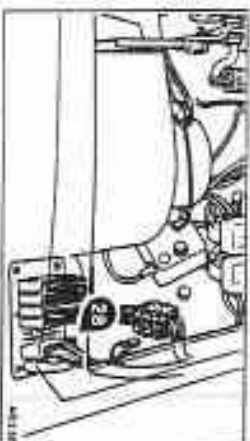
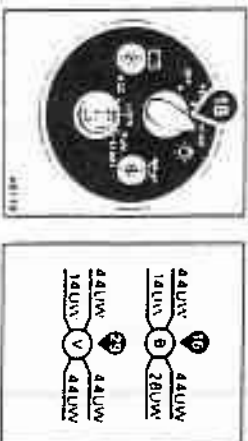
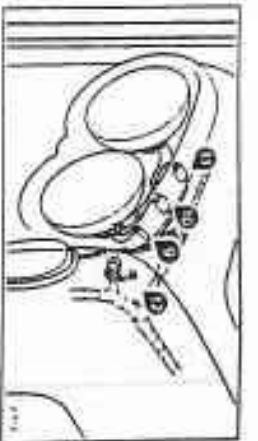
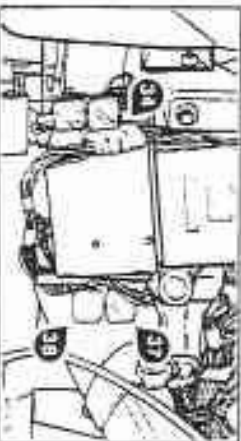
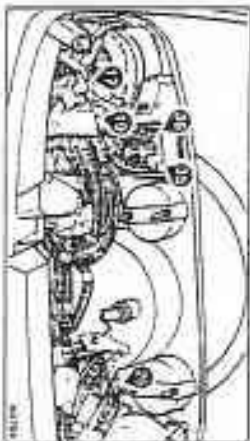
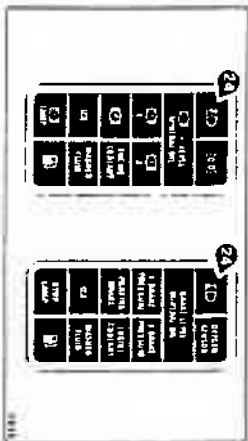
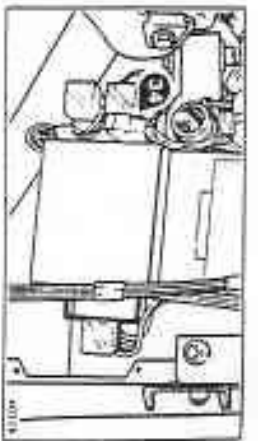
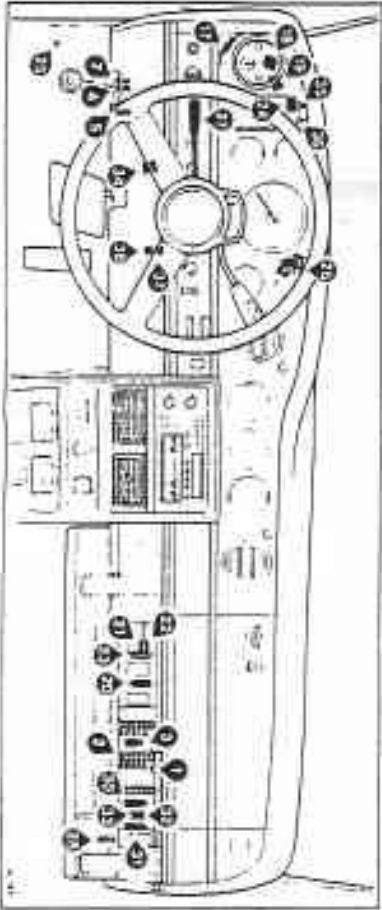
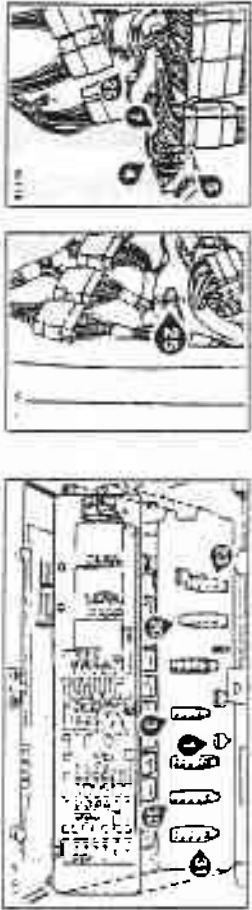
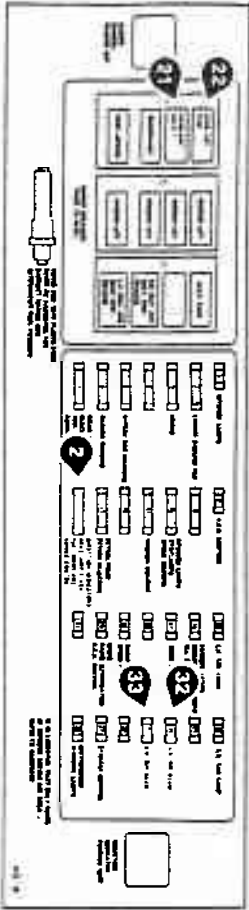
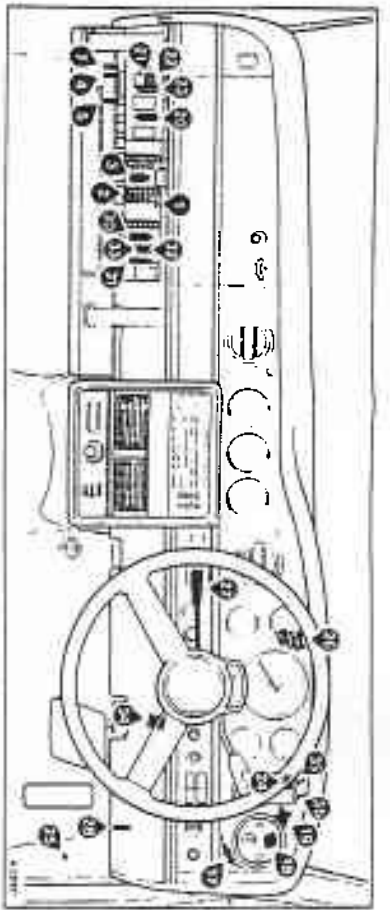

Headlamps



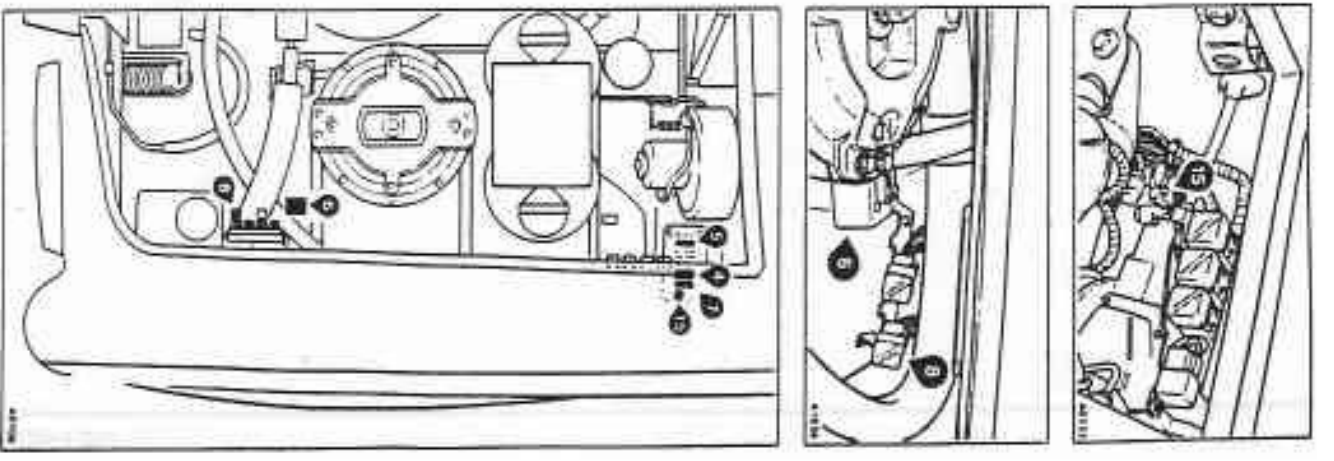
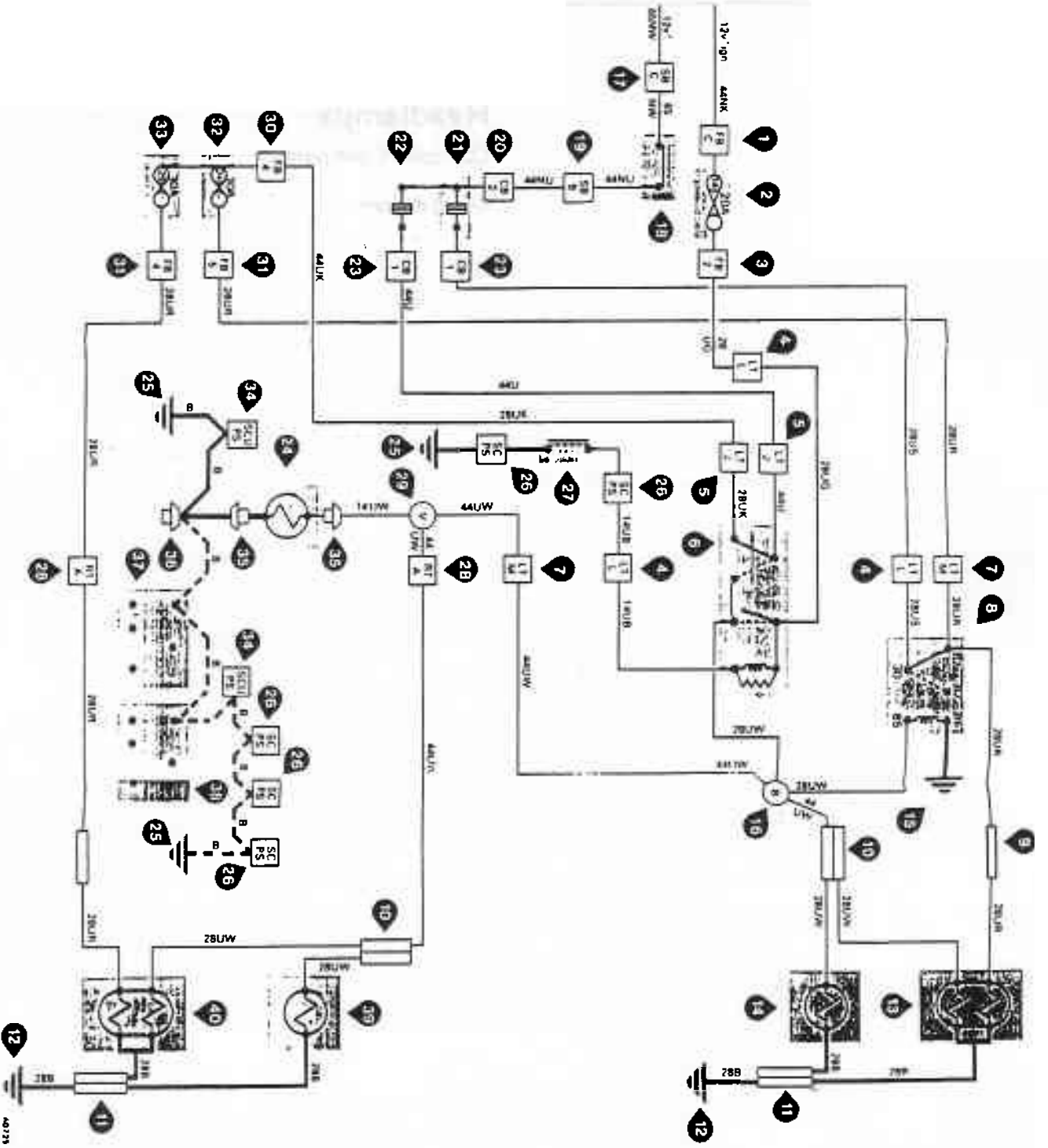

Corniche/Continental

Wiring diagram



From VIN *SCAZS0006GCX13860* (excluding Corniche/Continental) and with the exception of VIN *SCAZN0004FCH14000* to VIN *SCAZN0009FCH14025* inclusive, a new type of fuseboard is fitted incorporating Littell or Buss fuses (these fuses are not interchangeable with Bulgin type fuses).

Therefore when working to a wiring diagram or component location showing the earlier Bulgin type of fuse, reference must be made to the following table for its equivalent.

Circuits controlled	Bulgin fuse number 	Littell or Buss fuse number and fuseboard identification 	Fuse rating (amps)	Circuits controlled	Bulgin fuse number 	Littell or Buss fuse number and fuseboard identification 	Fuse rating (amps)
Cellular telephone when fitted	—	A1 - F2	4A	Rear window demister and mirror heaters	11	B4 - F3	20A
Cellular telephone when fitted	—	A2 - F2	10A	Reverse lamps, stoplamps, speed control, headlamp wash	10	B3 - F3	20A
Interior lamps	1	A6 - F2	10A	Direction indicators, headlamp flash, fuel door, horns control	14	B2 - F3	20A
Radio, panel illumination, ACU control	20	B1 - F2	10A	Cigar lighters, clock, aerial, fuel door	7	C4 - F3	20A
Radio amplifier when fitted	19	B2 - F2	10A	Engine cooling fan	2	C1 - F3	20A
Starter, ignition, fuel pump	27	B3 - F2	10A	Engine cooling fan	9	C1 - F3	20A
Instruments and warning lamps	28	B4 - F2	10A	Wipers and washers	5	B1 - F3	20A
ACU control	8	B5 - F2	10A	Spare	—	B6 - F3	20A
Spare	—	B6 - F2	10A	Fuel pump	13	B5 - F3	20A
L.H. Tail lamp	15	C1 - F2	10A	Horns	3	C3 - F3	20A
R.H. Tail lamp	22	C2 - F2	10A	Fog lamps when fitted	12	C6 - F3	20A
Parking lamps, number plate lamps, W.L. dim control	16	C3 - F2	10A	Air horns when fitted	4	C5 - F3	20A
L.H. Dip beam	24	C4 - F2	10A	Hazard warning	6	C2 - F3	20A
R.H. Dip beam	25	C5 - F2	10A				
Spare	—	C6 - F2	10A				
Spare	—	A6 - F3	20A				

For fuse identification refer to Section M1, General information, page M1-3.

Headlamps power wash

Wiring diagram

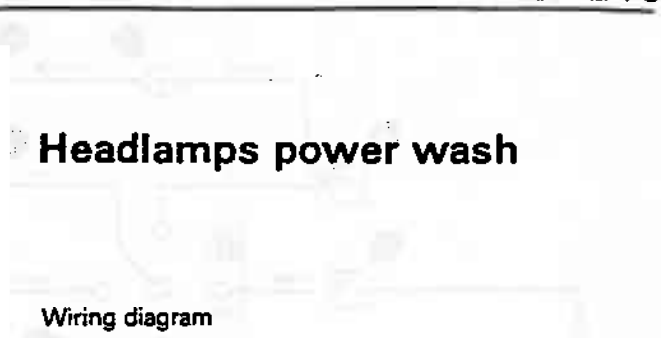

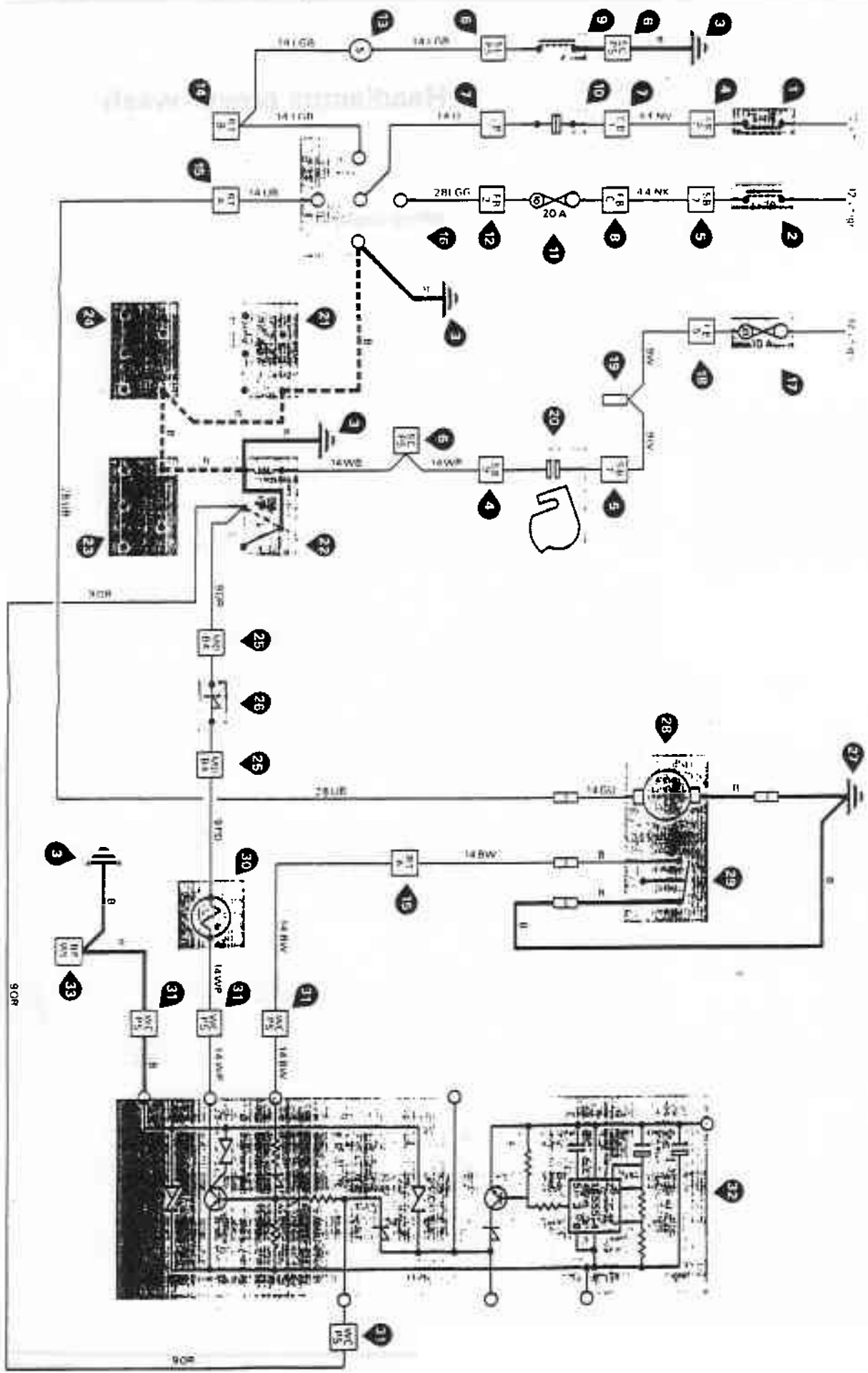

90R

Stop lamps and reversing lamps

Component location

Stop lamps and reversing lamps

Wiring diagram

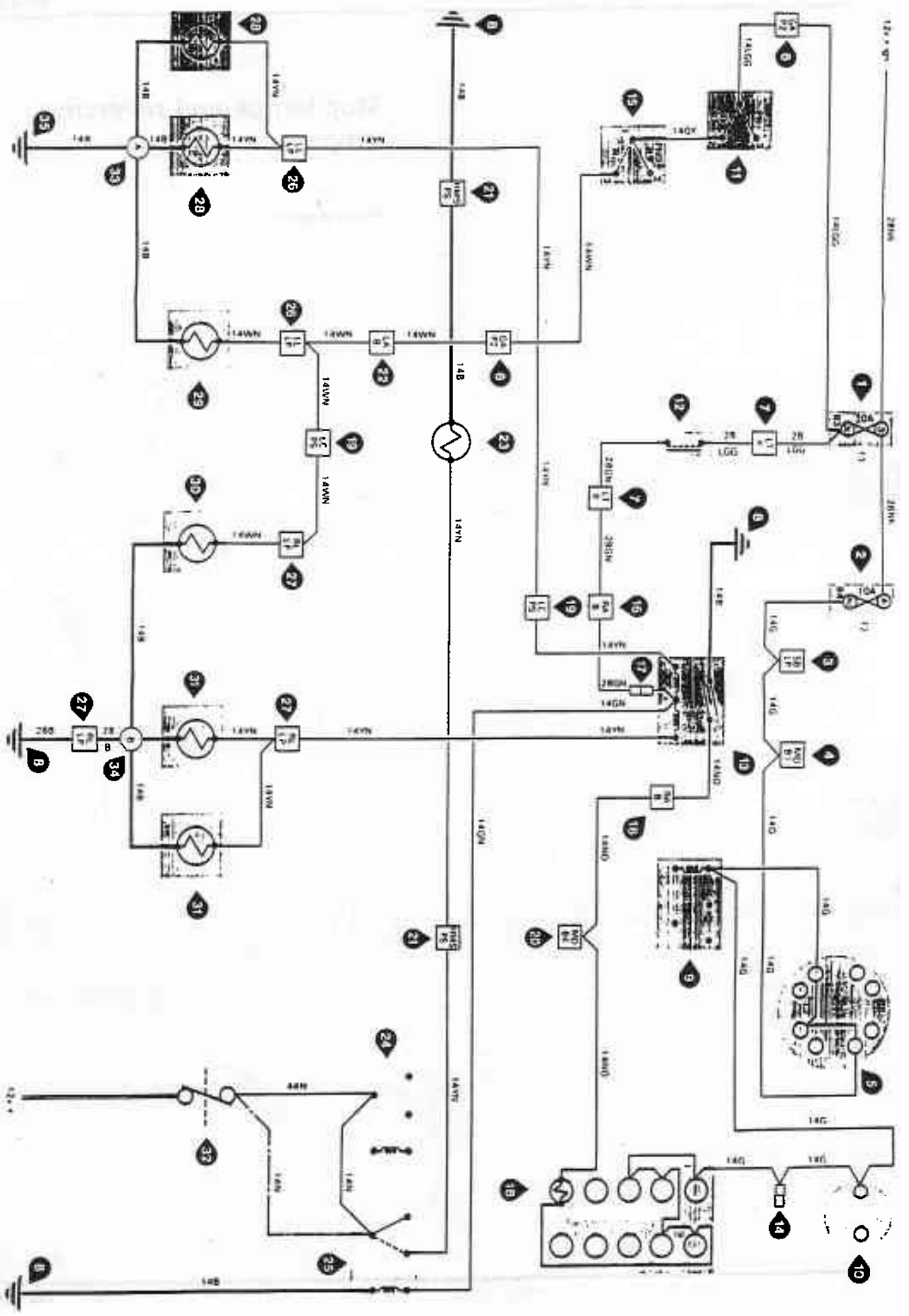

Side/position and tail lamps

Wiring diagram and component location



The facis warning lamp is not fitted on cars conforming to a North American or Japanese specification.



The side/position lamps items 40 and 43, and the luggage compartment lid tail lamps items 41 and 42 are only fitted on cars conforming to a North American specification.

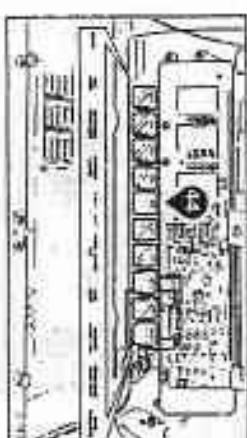
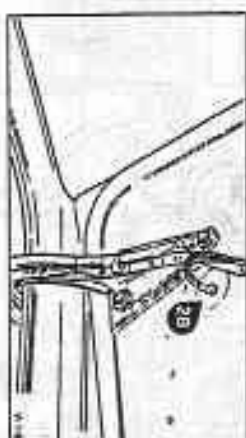
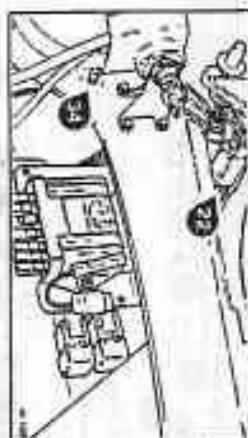

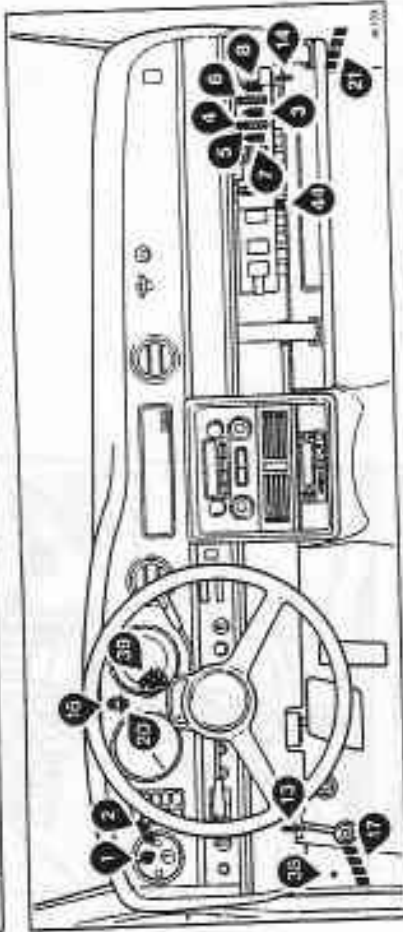
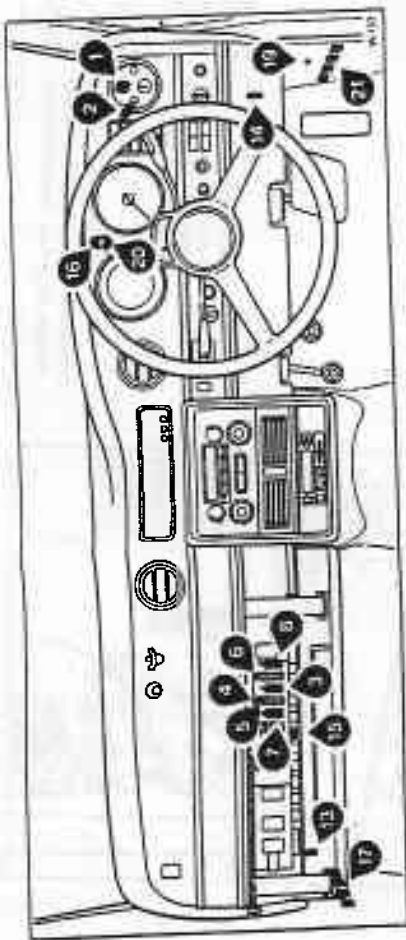
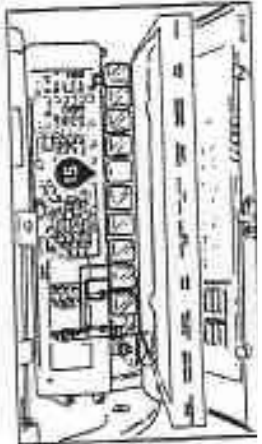
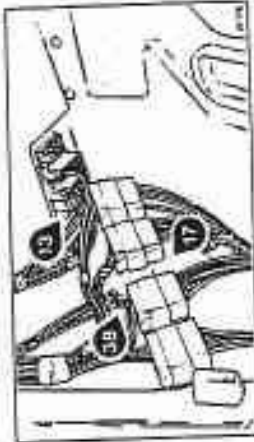
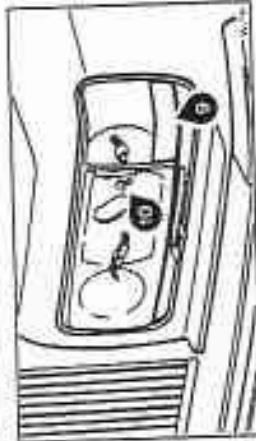
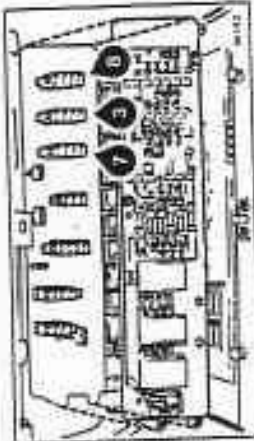
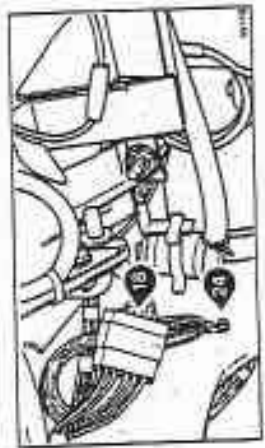
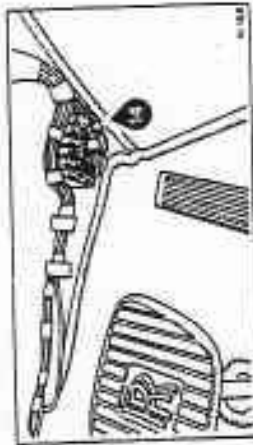
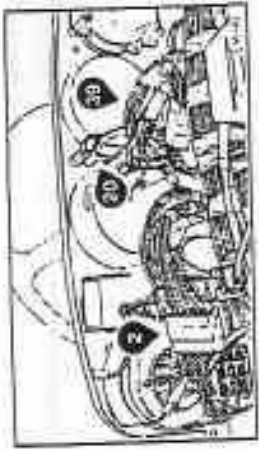

1.4L	1.6L	1.8L	2.0L	2.4L	2.8L	3.0L	3.5L	4.0L	4.5L	5.0L
1.4L	1.6L	1.8L	2.0L	2.4L	2.8L	3.0L	3.5L	4.0L	4.5L	5.0L
1.4L	1.6L	1.8L	2.0L	2.4L	2.8L	3.0L	3.5L	4.0L	4.5L	5.0L
1.4L	1.6L	1.8L	2.0L	2.4L	2.8L	3.0L	3.5L	4.0L	4.5L	5.0L
1.4L	1.6L	1.8L	2.0L	2.4L	2.8L	3.0L	3.5L	4.0L	4.5L	5.0L
1.4L	1.6L	1.8L	2.0L	2.4L	2.8L	3.0L	3.5L	4.0L	4.5L	5.0L
1.4L	1.6L	1.8L	2.0L	2.4L	2.8L	3.0L	3.5L	4.0L	4.5L	5.0L
1.4L	1.6L	1.8L	2.0L	2.4L	2.8L	3.0L	3.5L	4.0L	4.5L	5.0L
1.4L	1.6L	1.8L	2.0L	2.4L	2.8L	3.0L	3.5L	4.0L	4.5L	5.0L
1.4L	1.6L	1.8L	2.0L	2.4L	2.8L	3.0L	3.5L	4.0L	4.5L	5.0L

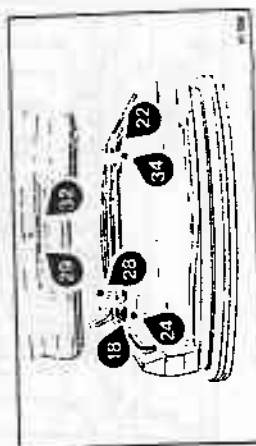

Side/position and tail lamps

Right-hand drive cars

Wiring diagram and component location

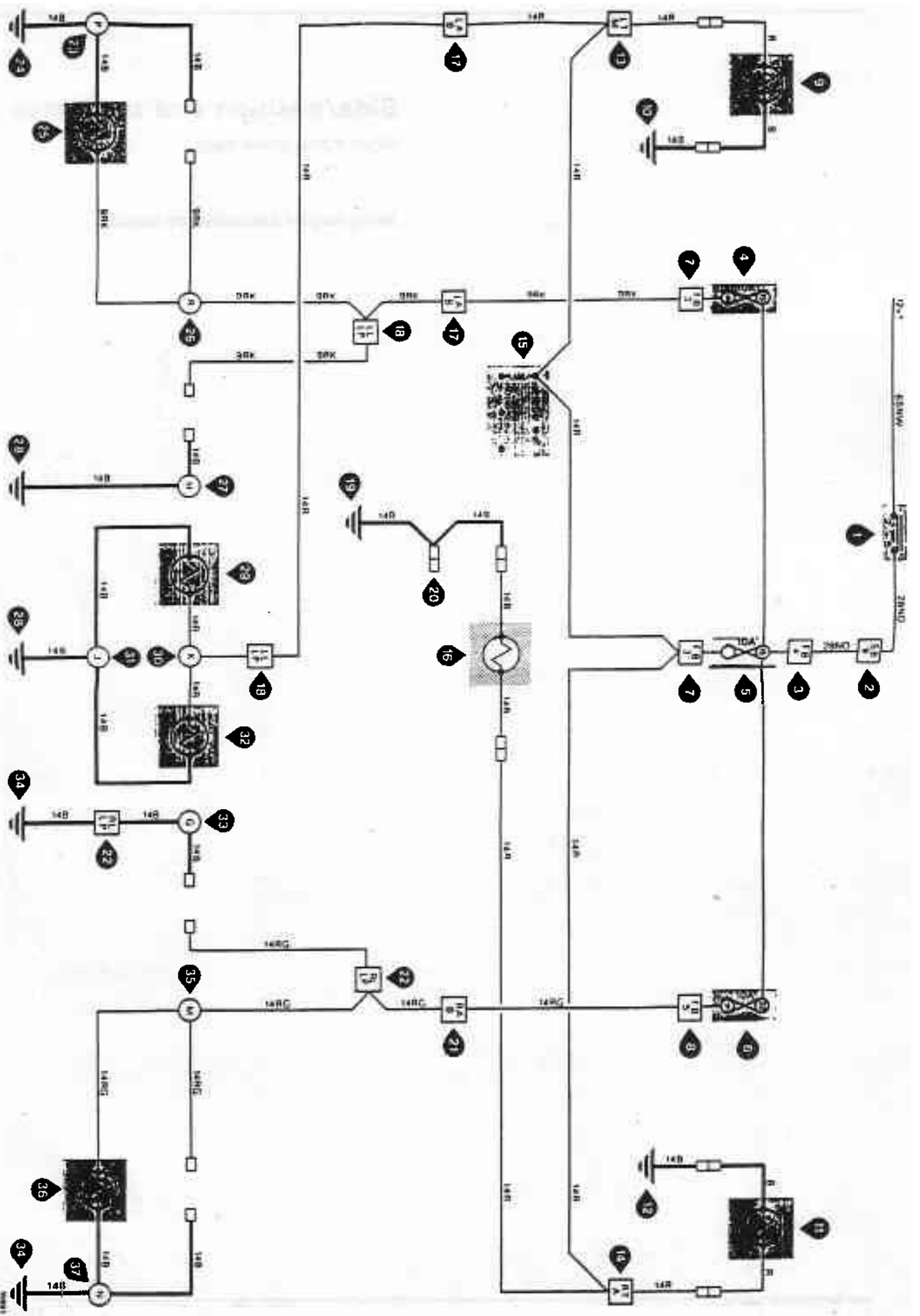

**Facia stowage compartment,
fuseboard, luggage
compartment, and engine
compartment illumination**

Wiring diagram

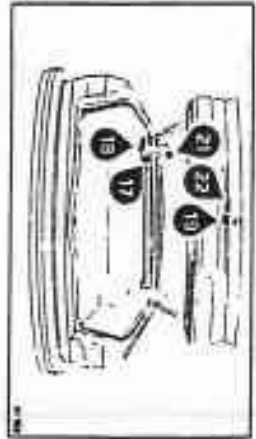
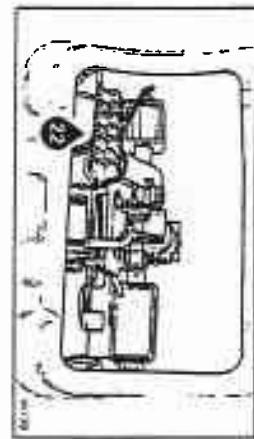
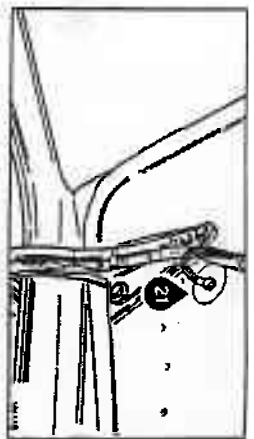
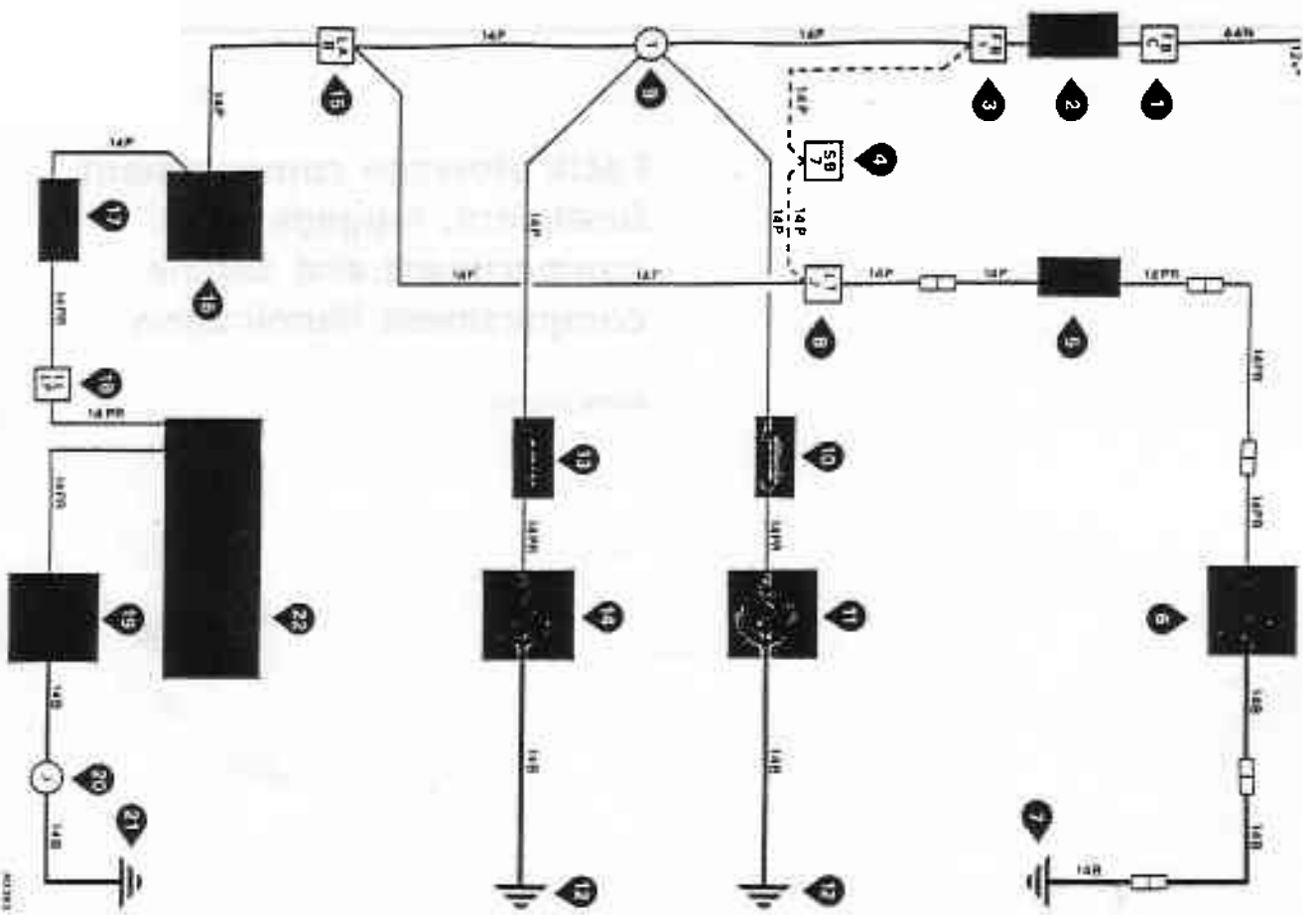

12V

Interior lamps and seat belt warning

Right-hand drive cars

Wiring diagram and component location

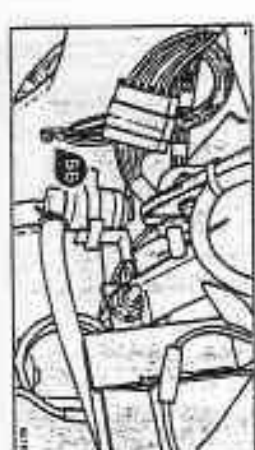
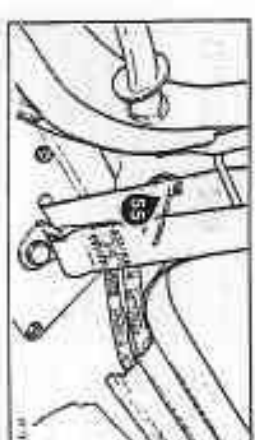
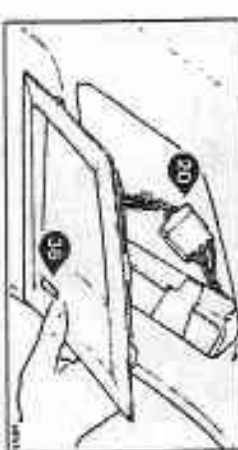
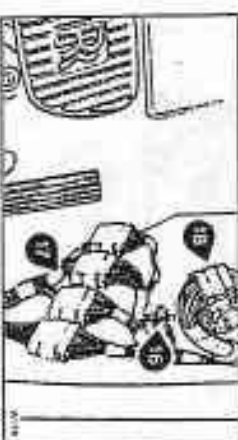
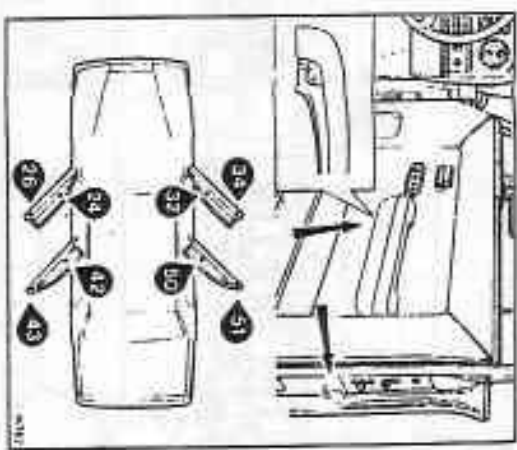
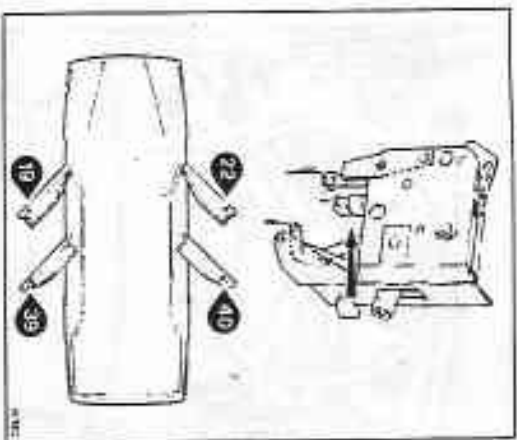

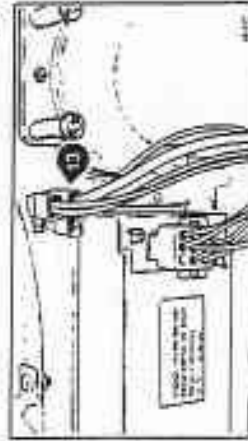
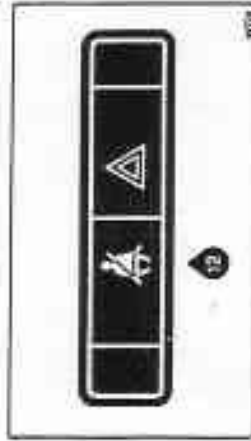
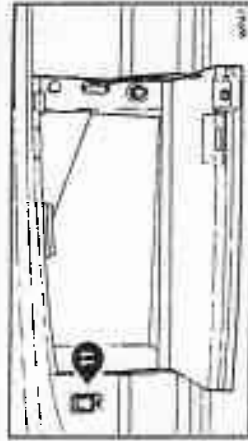
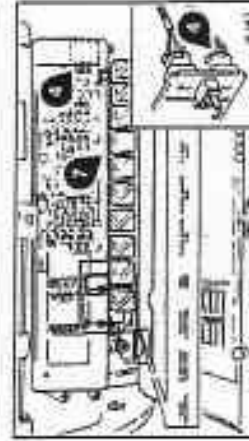
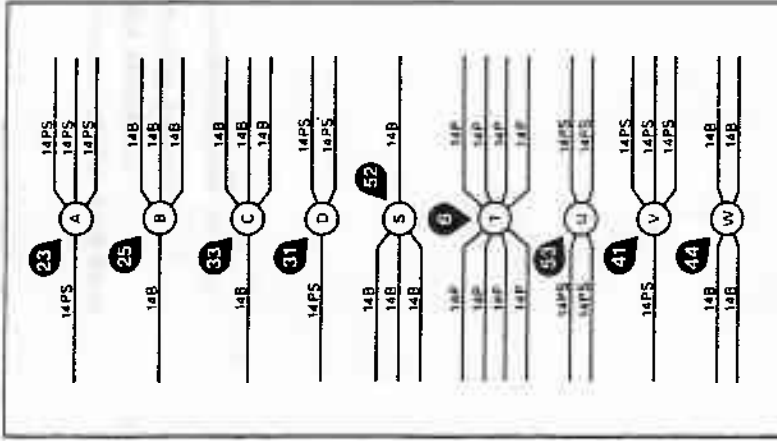
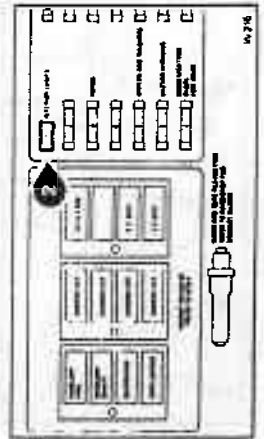
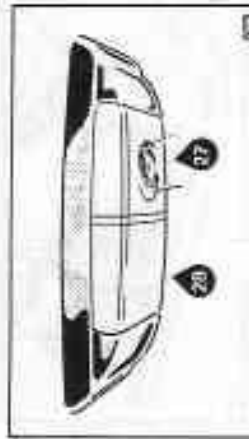
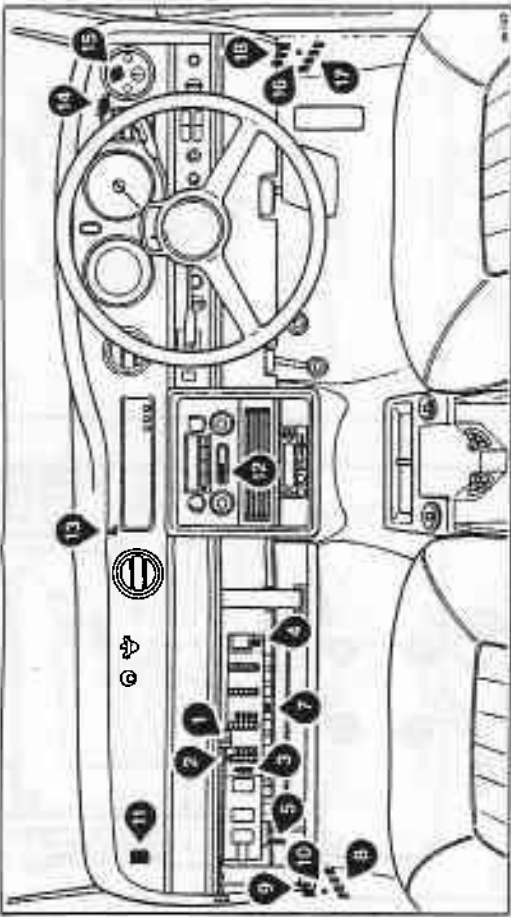

**Interior lamps and seat
belt warning**

Right-hand drive cars

Wiring diagram and component location

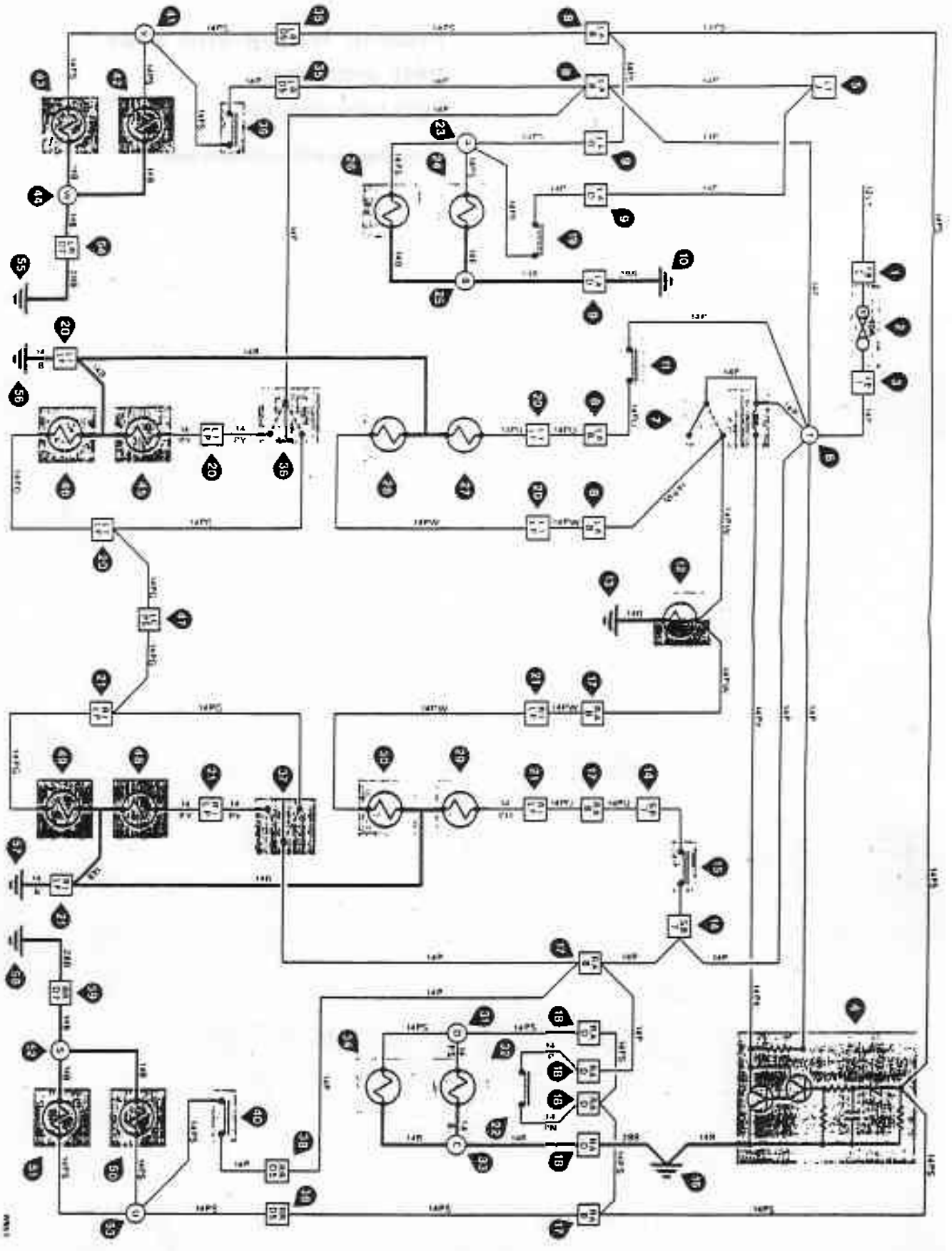

Interior lamps and seat belt warning

Right-hand drive cars

Component location

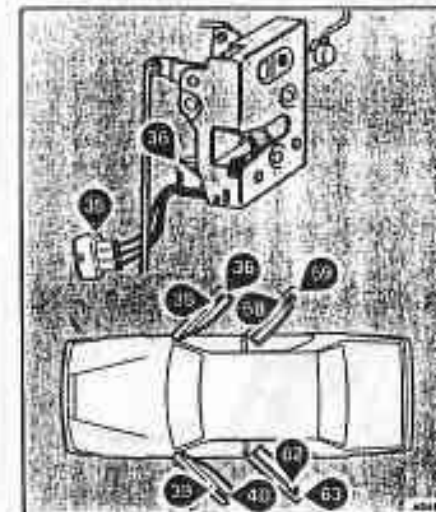
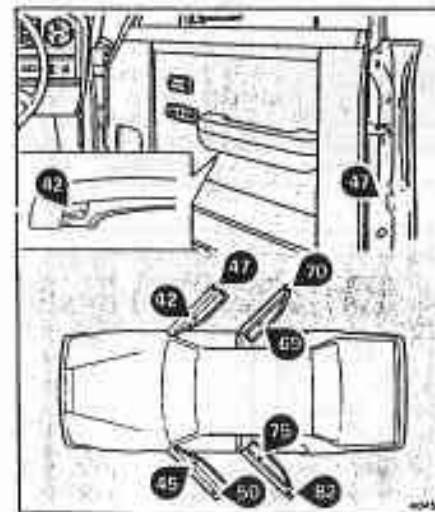
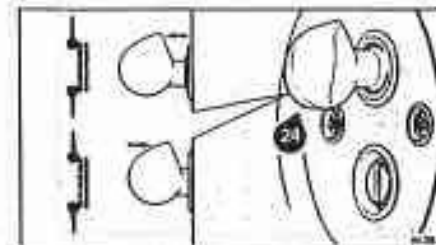
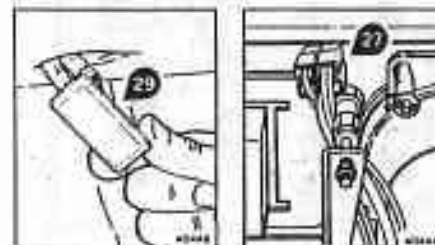
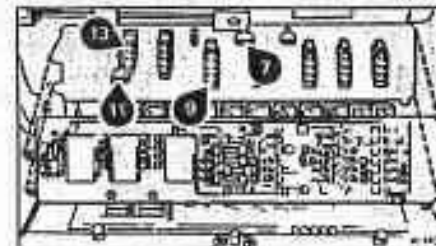
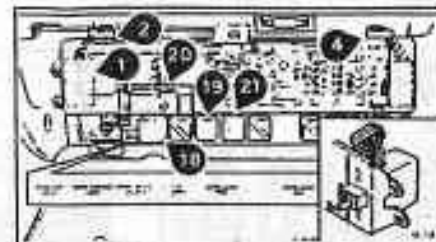
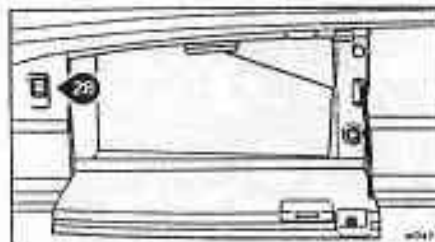

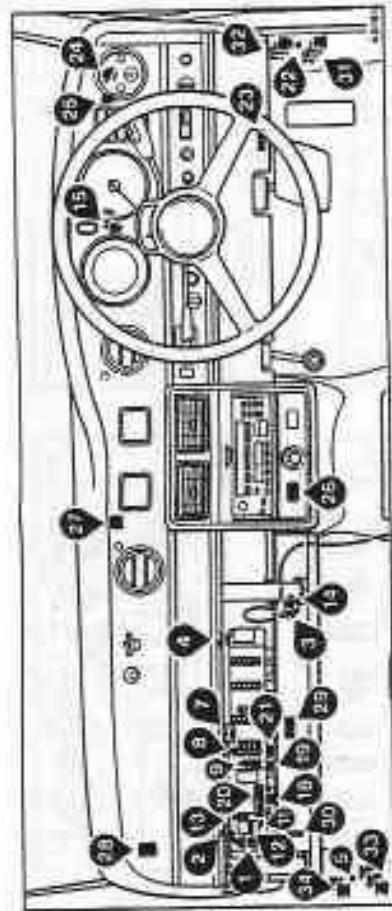

Note
Items 16 and 17 are not applicable to Bentley
Eight cars

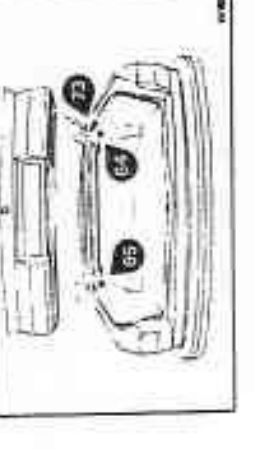
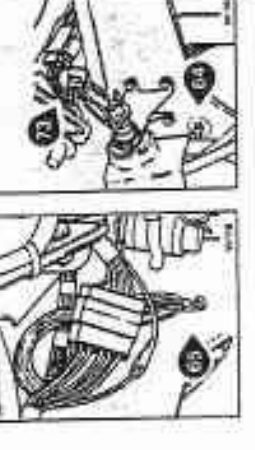
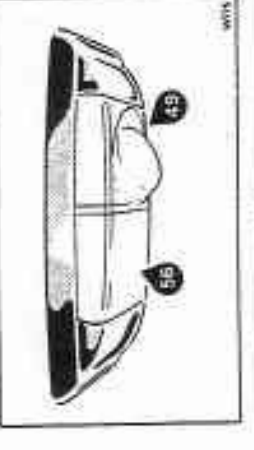
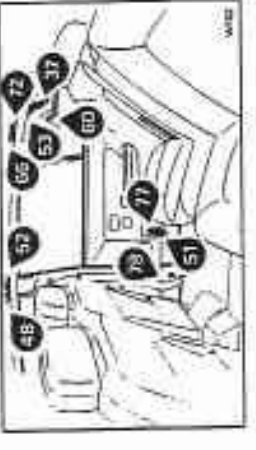
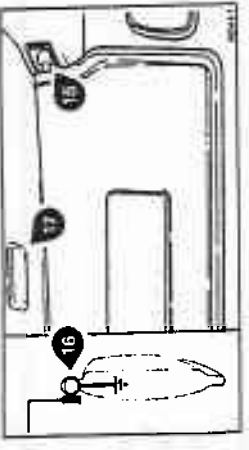
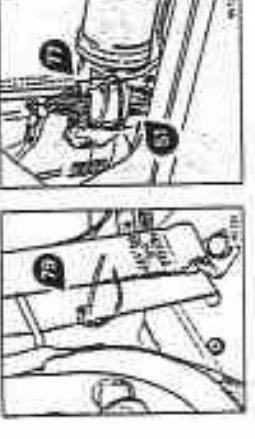
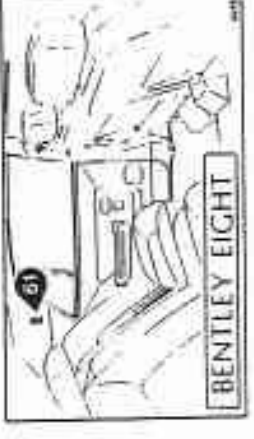
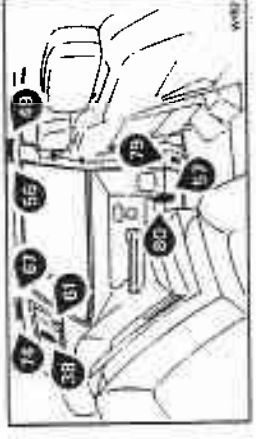
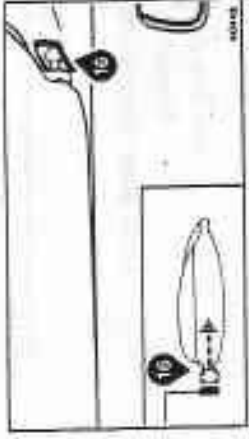
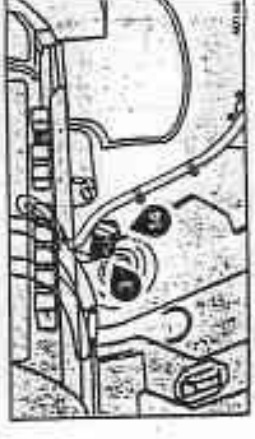
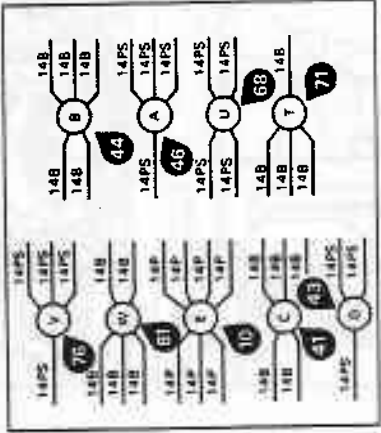

**Interior lamps and seat
belt warning**

Right-hand drive cars

Component location

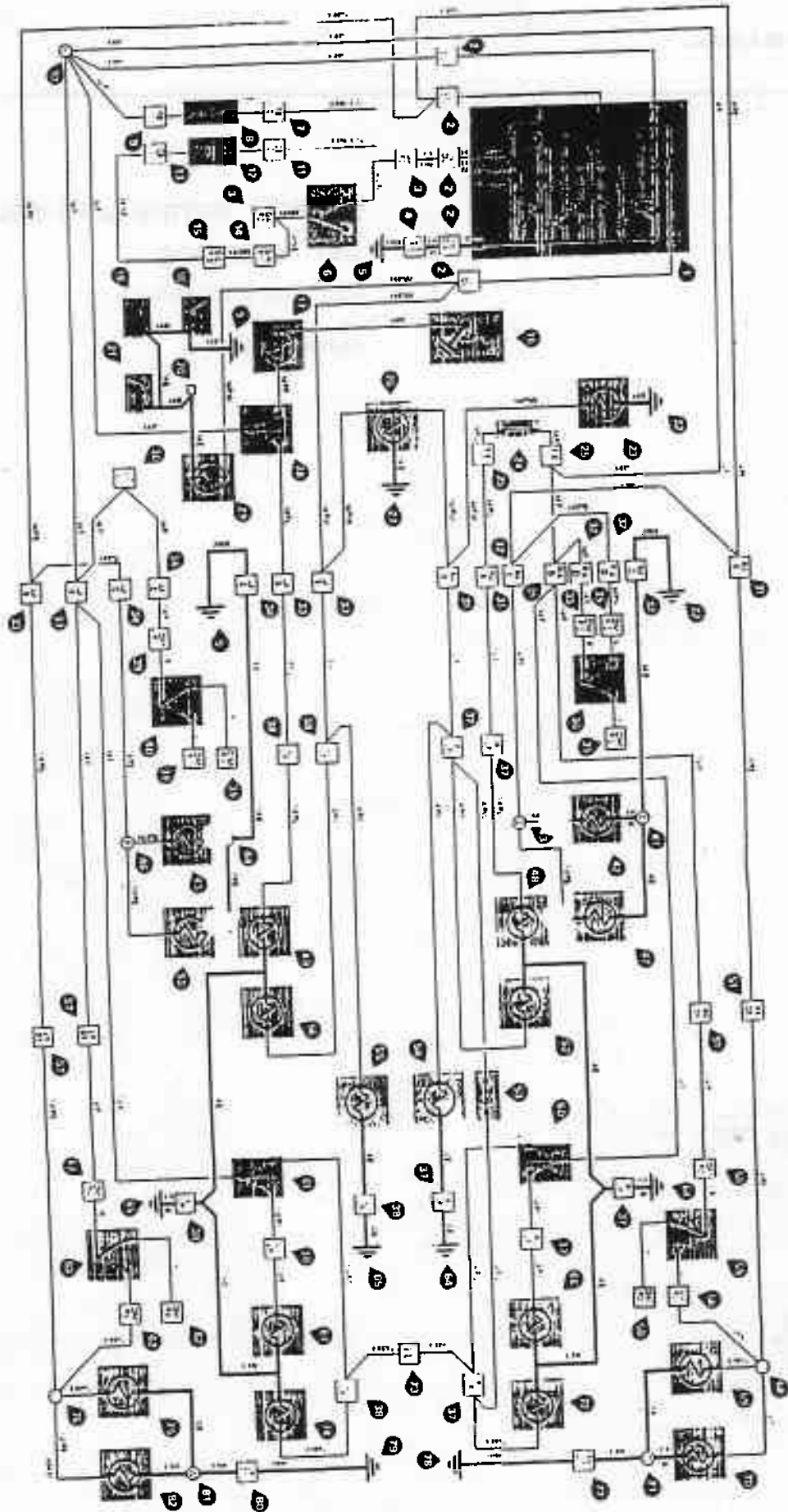

**Interior lamps and seat
belt warning**

Right-hand drive cars

Wiring diagram

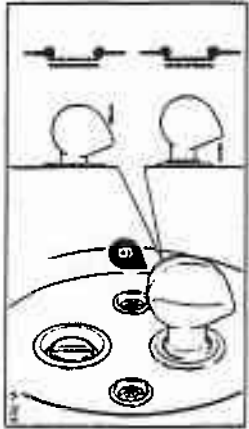
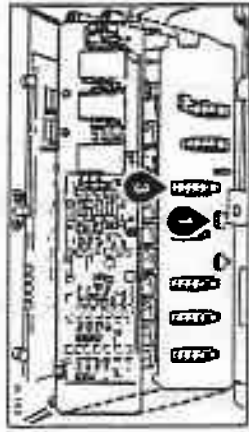
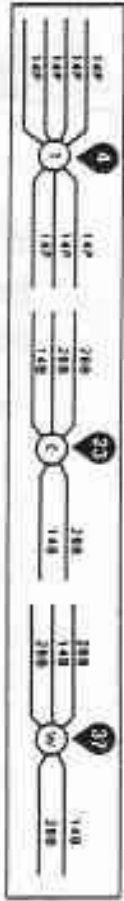
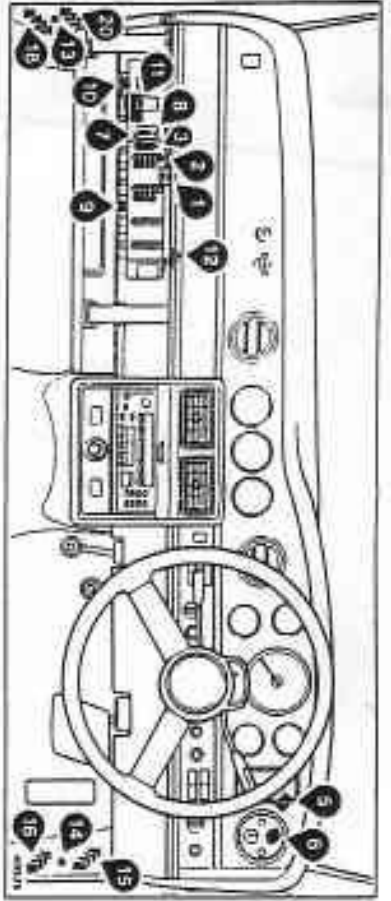

Callout	Component	Callout	Component
56	Left Side Mirror	60	Right Side Mirror
57	Left Side Window	61	Right Side Window
58	Left Side Door	62	Right Side Door
59	Left Side Panel	63	Right Side Panel
64	Left Side Seat	65	Right Side Seat
66	Left Side Floor	67	Right Side Floor
68	Left Side Console	69	Right Side Console
70	Left Side Storage	71	Right Side Storage
72	Left Side Armrest	73	Right Side Armrest
74	Left Side Headrest	75	Right Side Headrest
76	Left Side Backrest	77	Right Side Backrest
78	Left Side Footrest	79	Right Side Footrest
80	Left Side Headrest	81	Right Side Headrest
82	Left Side Backrest	83	Right Side Backrest
84	Left Side Footrest	85	Right Side Footrest

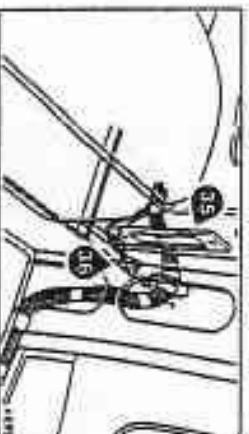
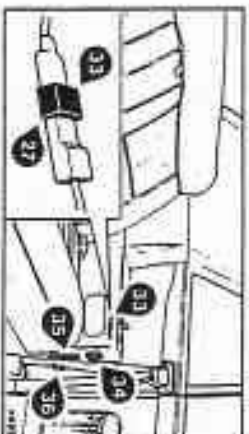
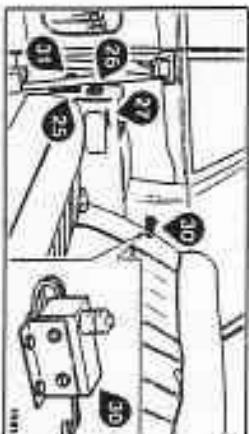
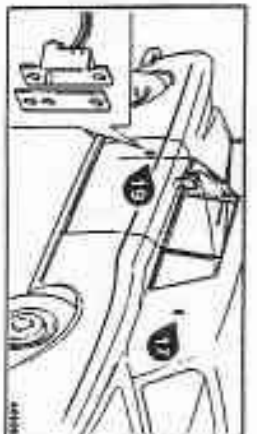
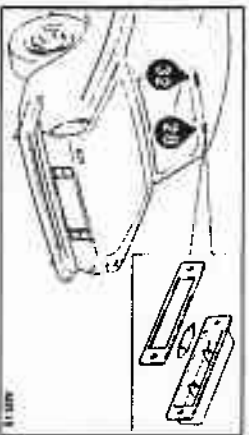
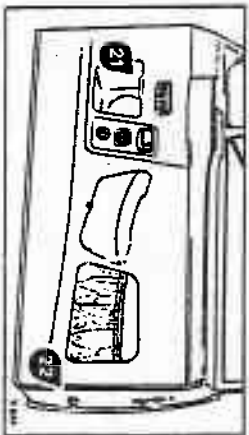
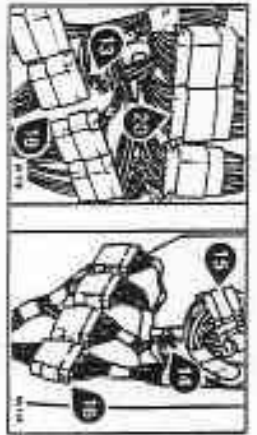
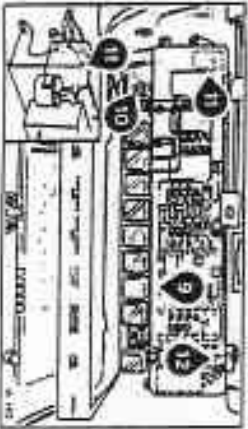
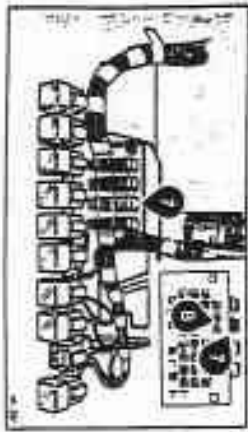

40 ↑ To hood down temperature relay, see TSD 4417, Chapter C

**Interior lamps and seat
belt warning**

**Corniche and Continental
Right-hand drive cars**

Component location

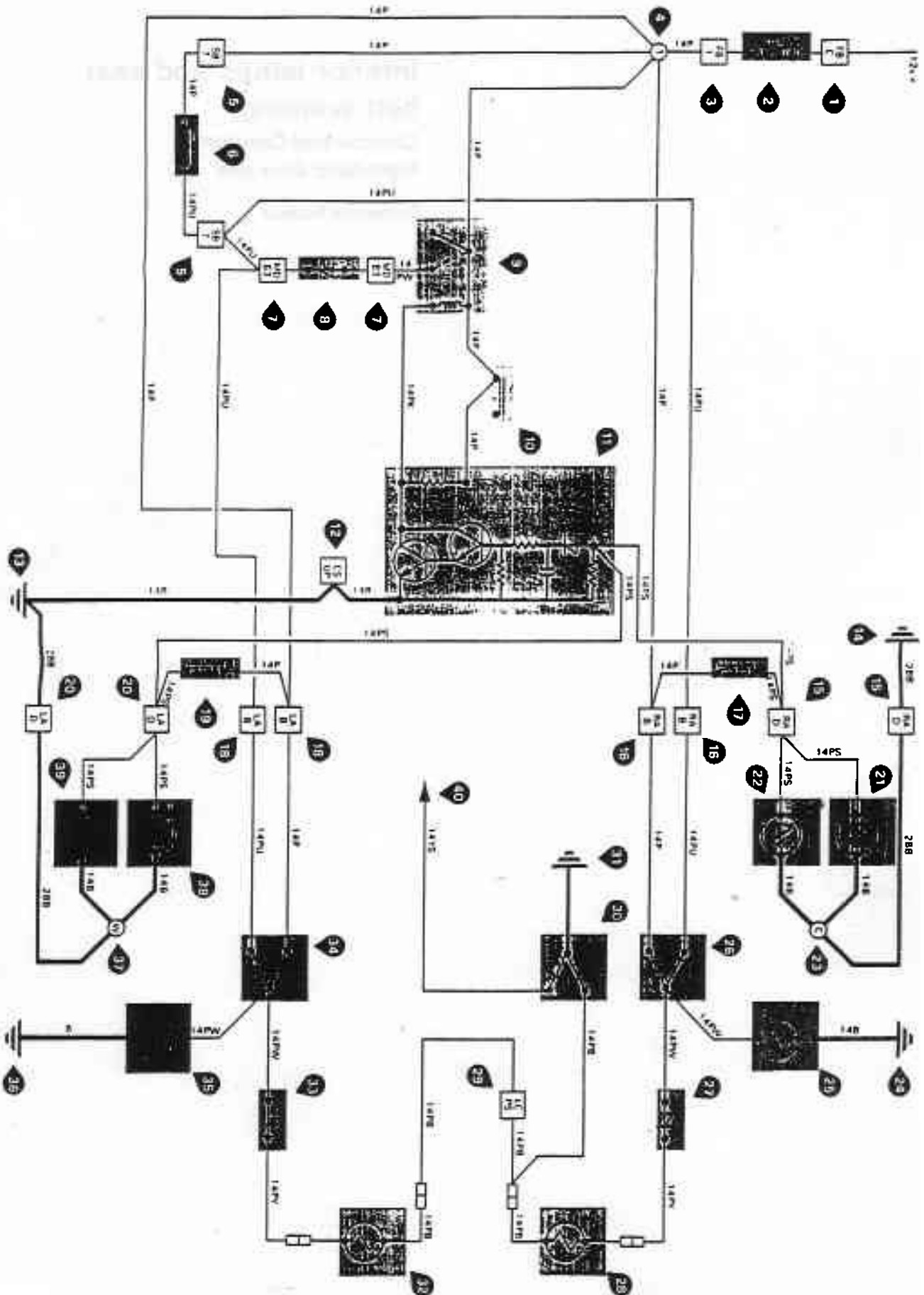

Interior lamps and seat belt warning

Left-hand drive cars other than those conforming to a North American specification

Wiring diagram and component location

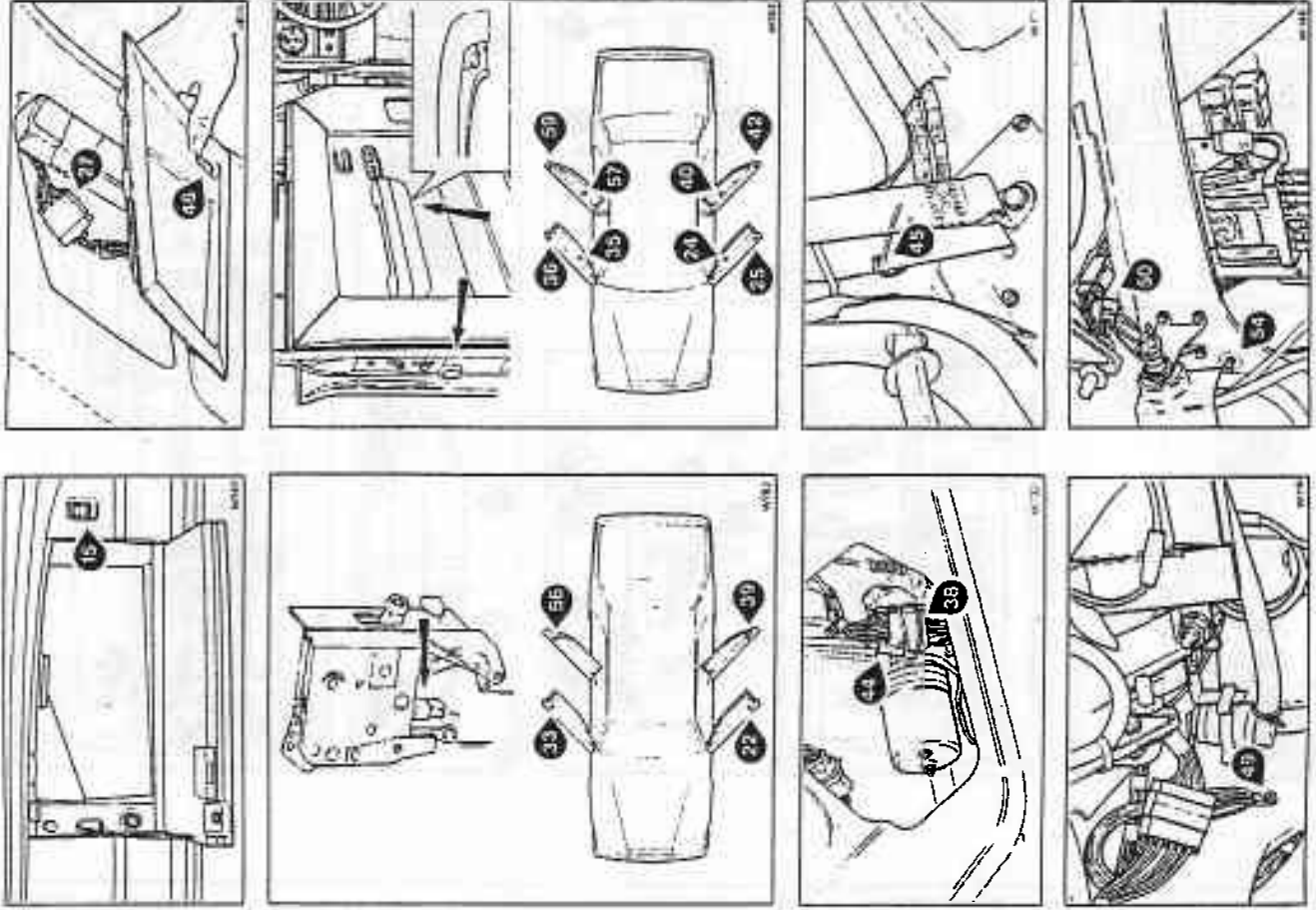

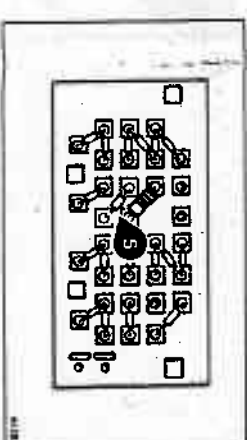
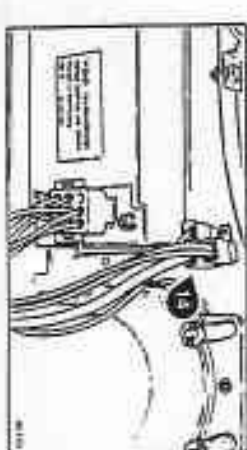
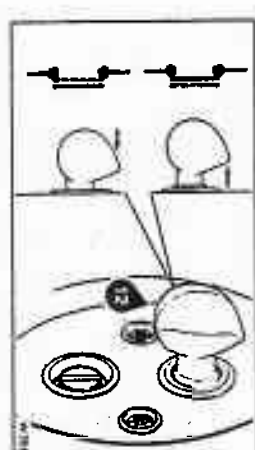
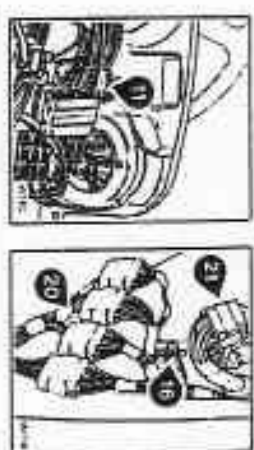
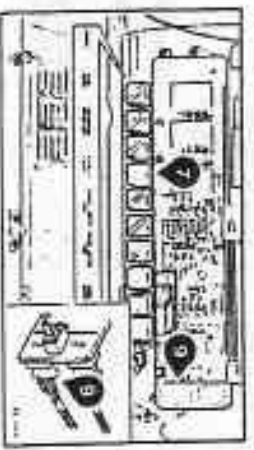
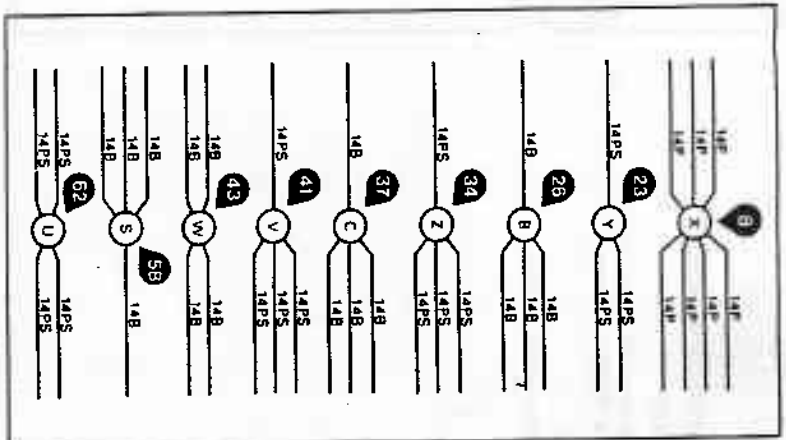
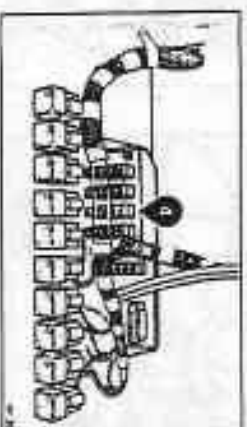
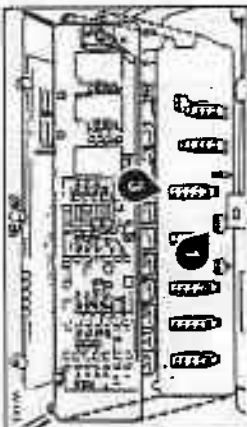
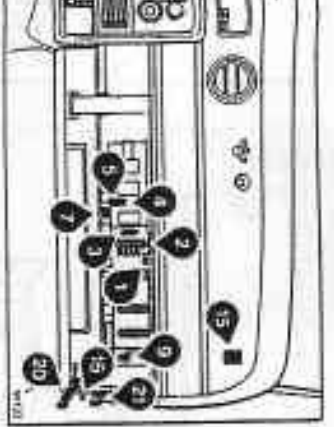
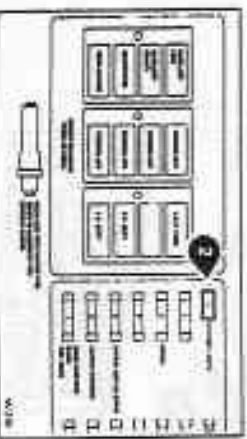
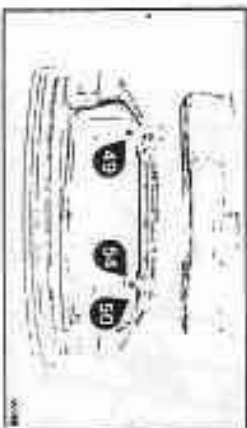
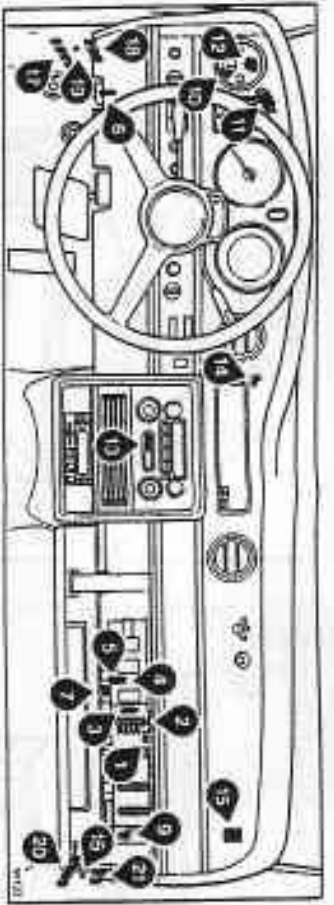

Interior lamps and seat belt warning

Left-hand drive cars other than those
conforming to a North American
specification

Component location

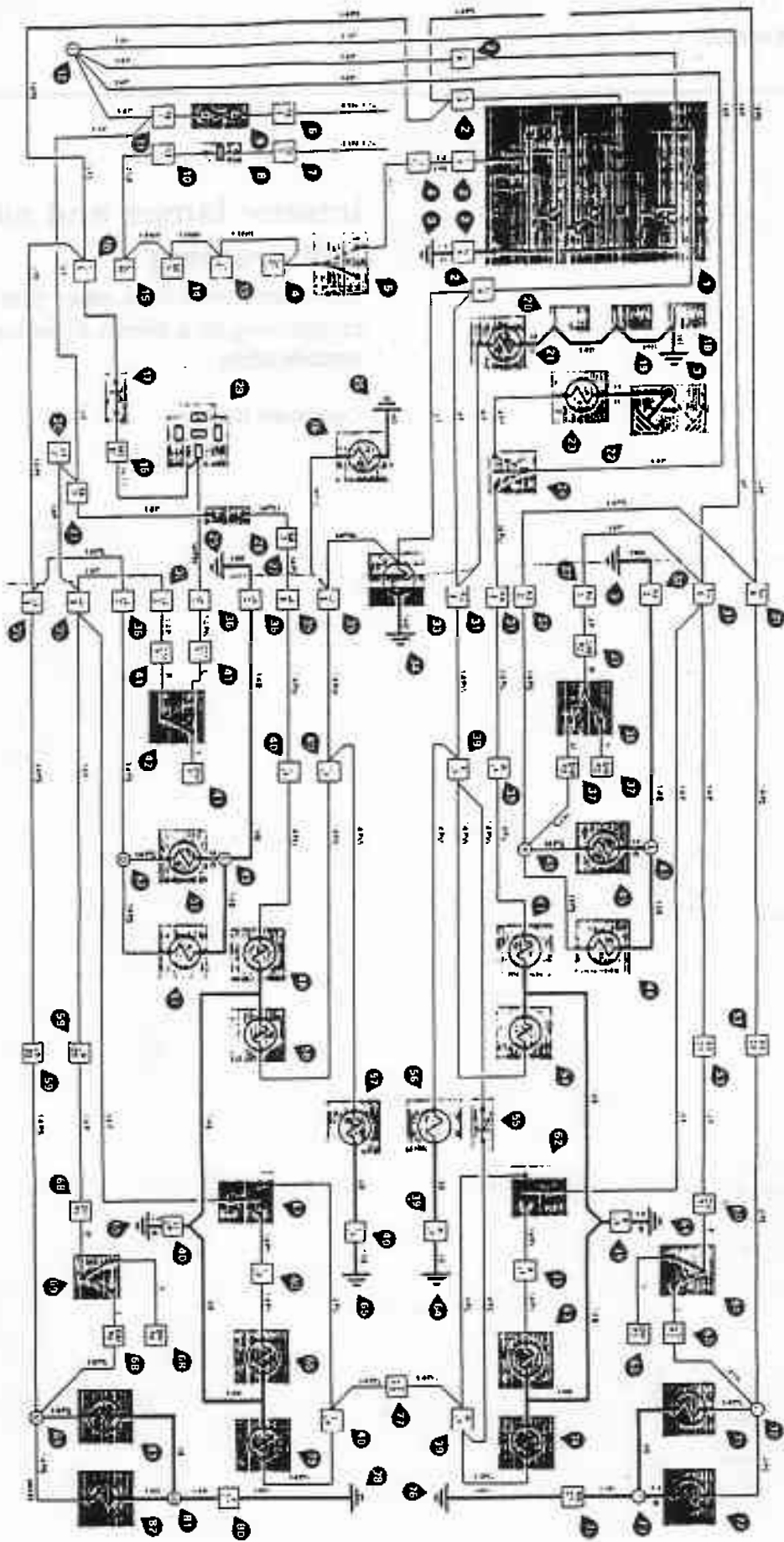

Interior lamps

Cars conforming to a North American specification

Wiring diagram and component location

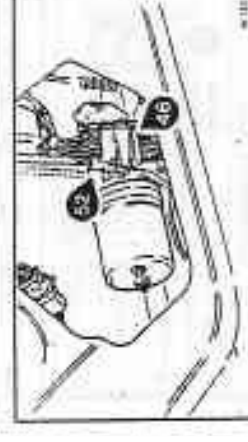
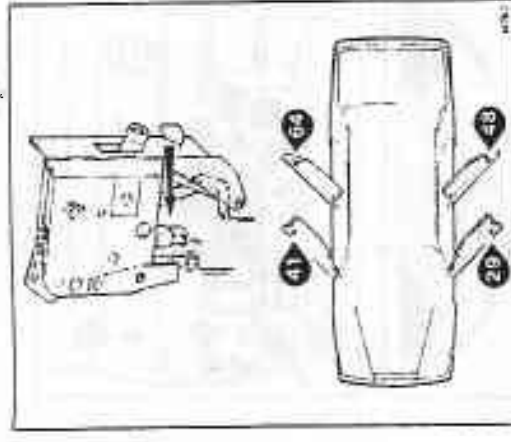
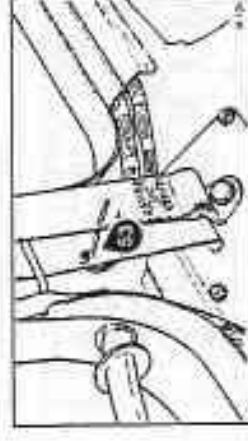
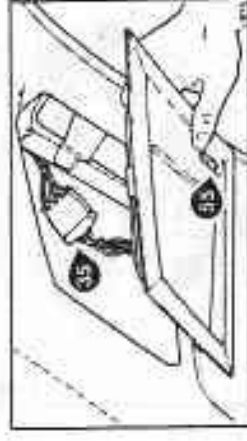
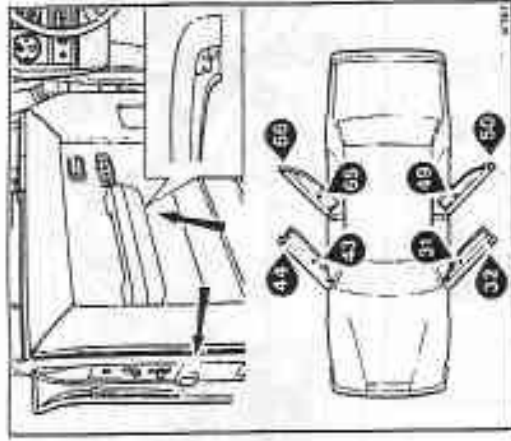





Panel lamps

Contents	Pages					
	Silver Spirit Mulsanne	Silver Spur	Mulsanne Turbo	Bentley Eight	Bentley Turbo R	Corniche/ Continental
Component location	M16-3	M16-3	M16-3	—	M16-9	M16-3
Wiring diagram						
Cars fitted with a Bosch Frankfurt stereo radio and Pioneer cassette tape play unit	M16-5	M16-5	—	—	—	—
Cars fitted with a Blaupunkt combined radio/cassette tape play unit (Bremen, Toronto, Washington, and Geneva)						
Right-hand drive cars	M16-7	M16-7	M16-7	—	M16-11	M16-7
Left-hand drive cars	M16-7	M16-7	M16-7	—	M16-13	M16-7

M16-2

From VIN *SCAZS0006GCX13860* (excluding Corniche/Continental) and with the exception of VIN *SCAZN0004FCH14000* to VIN *SCAZN0009FCH14025* inclusive, a new type of fuseboard is fitted incorporating Littell or Buss fuses (these fuses are not interchangeable with Bulgin type fuses).

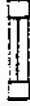
Therefore when working to a wiring diagram or component location showing the earlier Bulgin type of fuse, reference must be made to the following table for its equivalent.

Circuits controlled	Bulgin fuse number 	Littell or Buss fuse number and fuseboard identification 	Fuse rating (amps)	Circuits controlled	Bulgin fuse number 	Littell or Buss fuse number and fuseboard identification 	Fuse rating (amps)
Cellular telephone when fitted	—	A1 - F2	4A	Rear window demister and mirror heaters	11	B4 - F3	20A
Cellular telephone when fitted	—	A2 - F2	10A	Reverse lamps, stoplamps, speed control, headlamp wash	10	B3 - F3	20A
Interior lamps	1	A6 - F2	10A	Direction indicators, headlamp flash, fuel door, horns control	14	B2 - F3	20A
Radio, panel illumination, ACU control	20	B1 - F2	10A	Cigar lighters, clock, aerial, fuel door	7	C4 - F3	20A
Radio amplifier when fitted	19	B2 - F2	10A	Engine cooling fan	2	C1 - F3	20A
Starter, ignition, fuel pump	27	B3 - F2	10A	Engine cooling fan	9	C1 - F3	20A
Instruments and warning lamps	28	B4 - F2	10A	Wipers and washers	5	B1 - F3	20A
ACU control	8	B5 - F2	10A	Spare	—	B6 - F3	20A
Spare	—	B6 - F2	10A	Fuel pump	13	B5 - F3	20A
L.H. Tail lamp	15	C1 - F2	10A	Horns	3	C3 - F3	20A
R.H. Tail lamp	22	C2 - F2	10A	Fog lamps when fitted	12	C6 - F3	20A
Parking lamps, number plate lamps, W.L. dim control	16	C3 - F2	10A	Air horns when fitted	4	C5 - F3	20A
L.H. Dip beam	24	C4 - F2	10A	Hazard warning	6	C2 - F3	20A
R.H. Dip beam	25	C5 - F2	10A				
Spare	—	C6 - F2	10A				
Spare	—	A6 - F3	20A				

For fuse identification refer to Section M1, General information, page M1-3.

Panel lamps

Wiring diagram and component location

Panel lamps

Component location

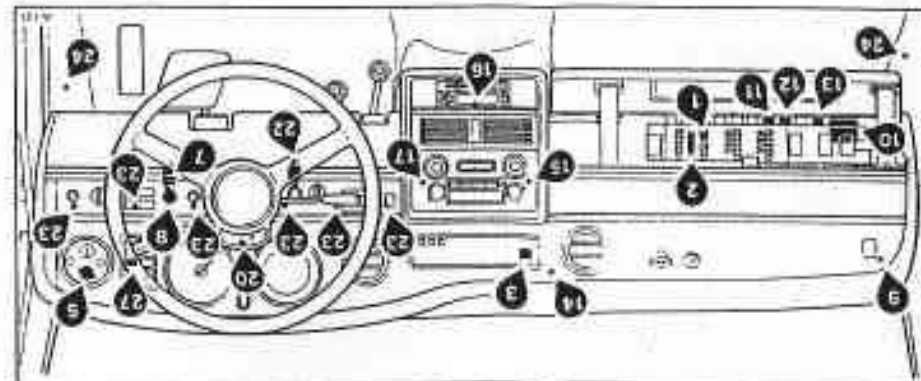
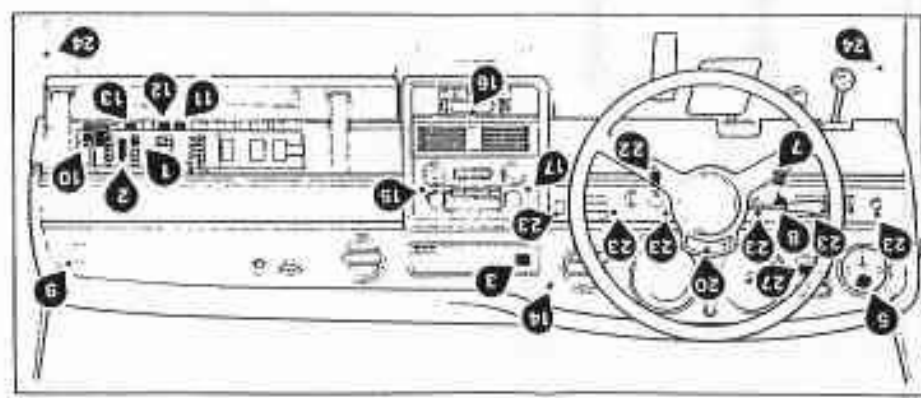
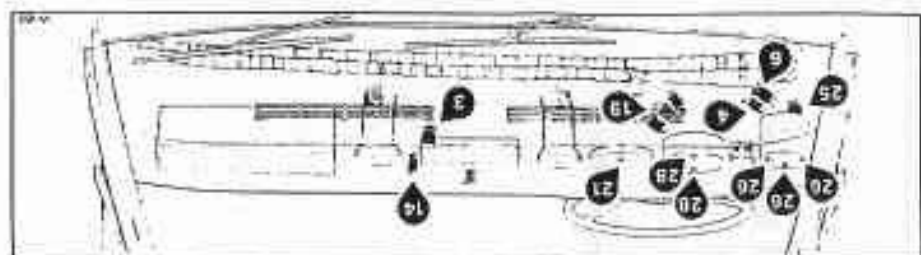
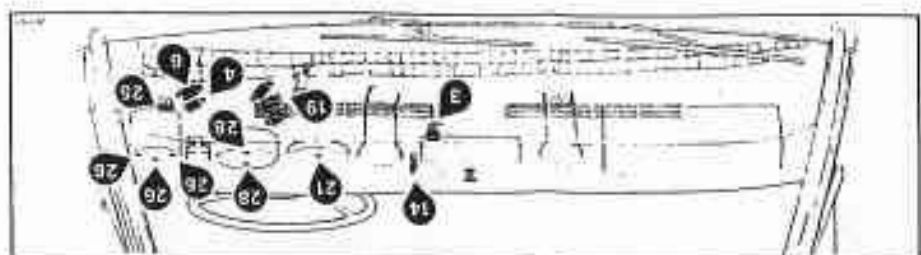
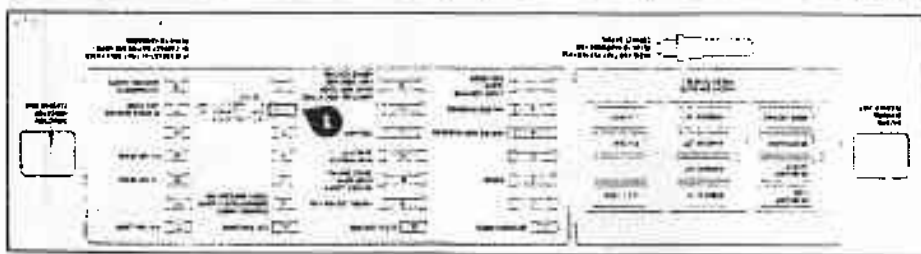
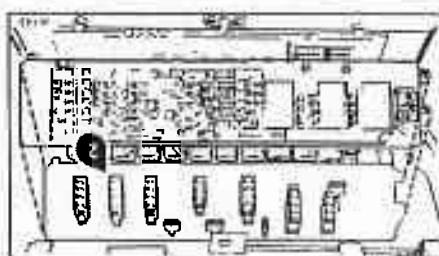
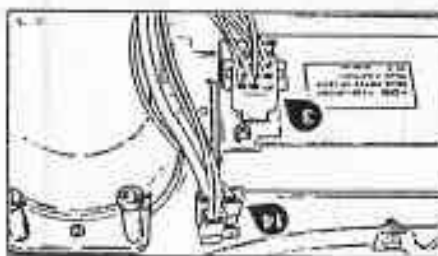
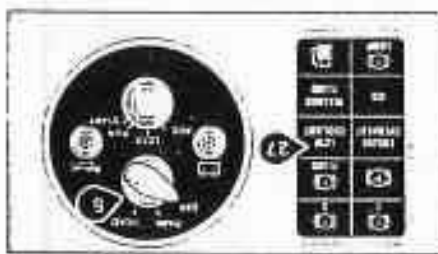
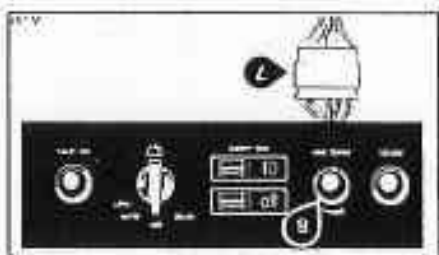
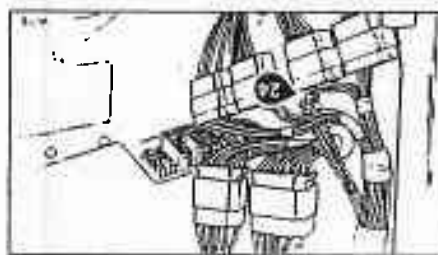
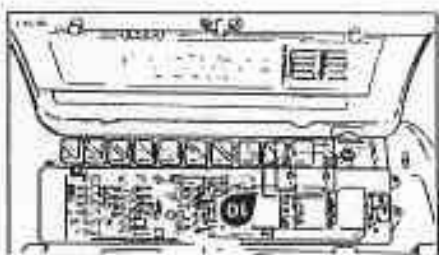
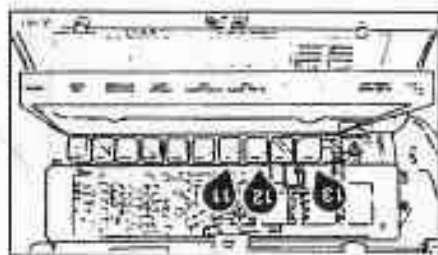

Panel lamps

Cars fitted with a Bosch Frankfurt stereo radio and Pioneer cassette tape play unit

Wiring diagram

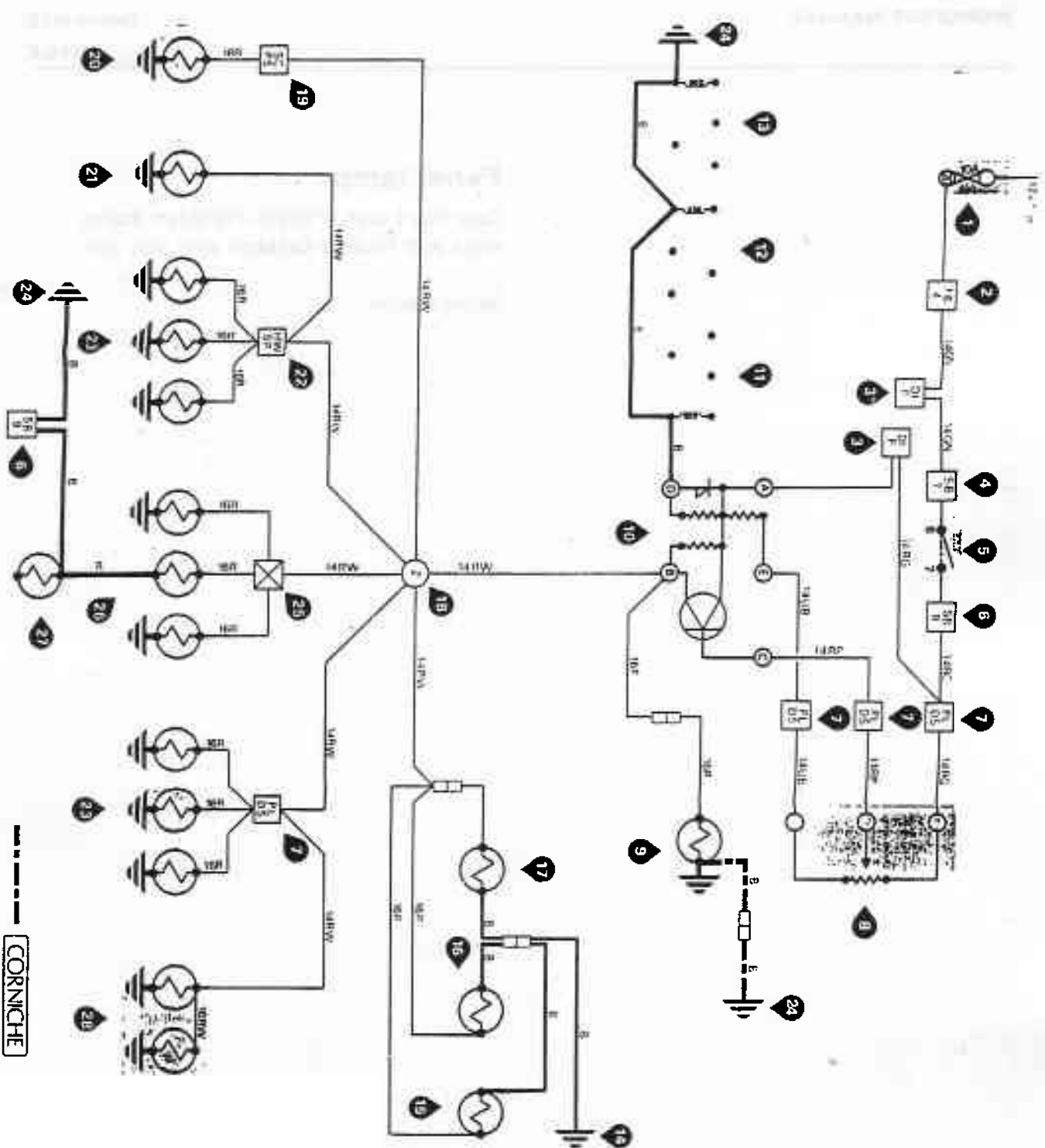

CORNICHE

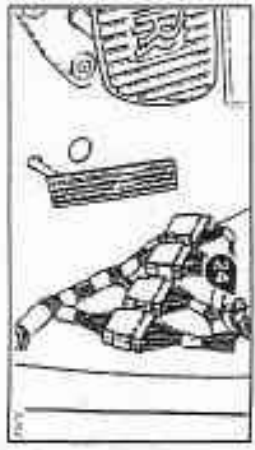
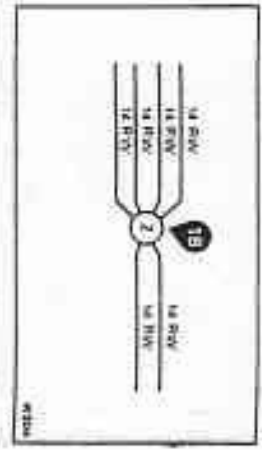

Panel lamps

Cars fitted with a Blaupunkt combined radio/cassette tape play unit. (Bremen, Toronto, Washington, and Geneva)

Wiring diagram

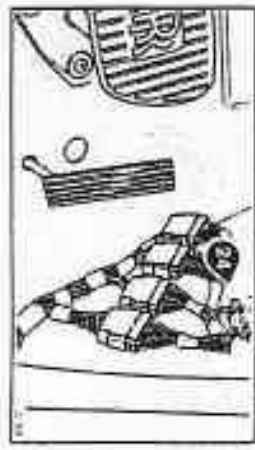
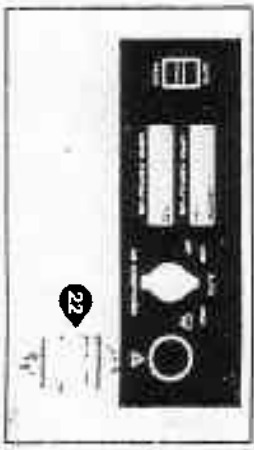
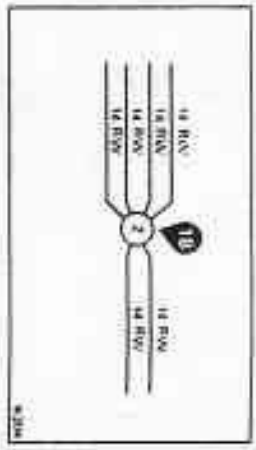
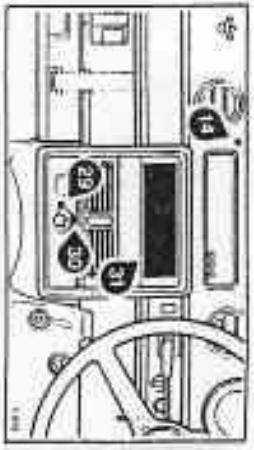
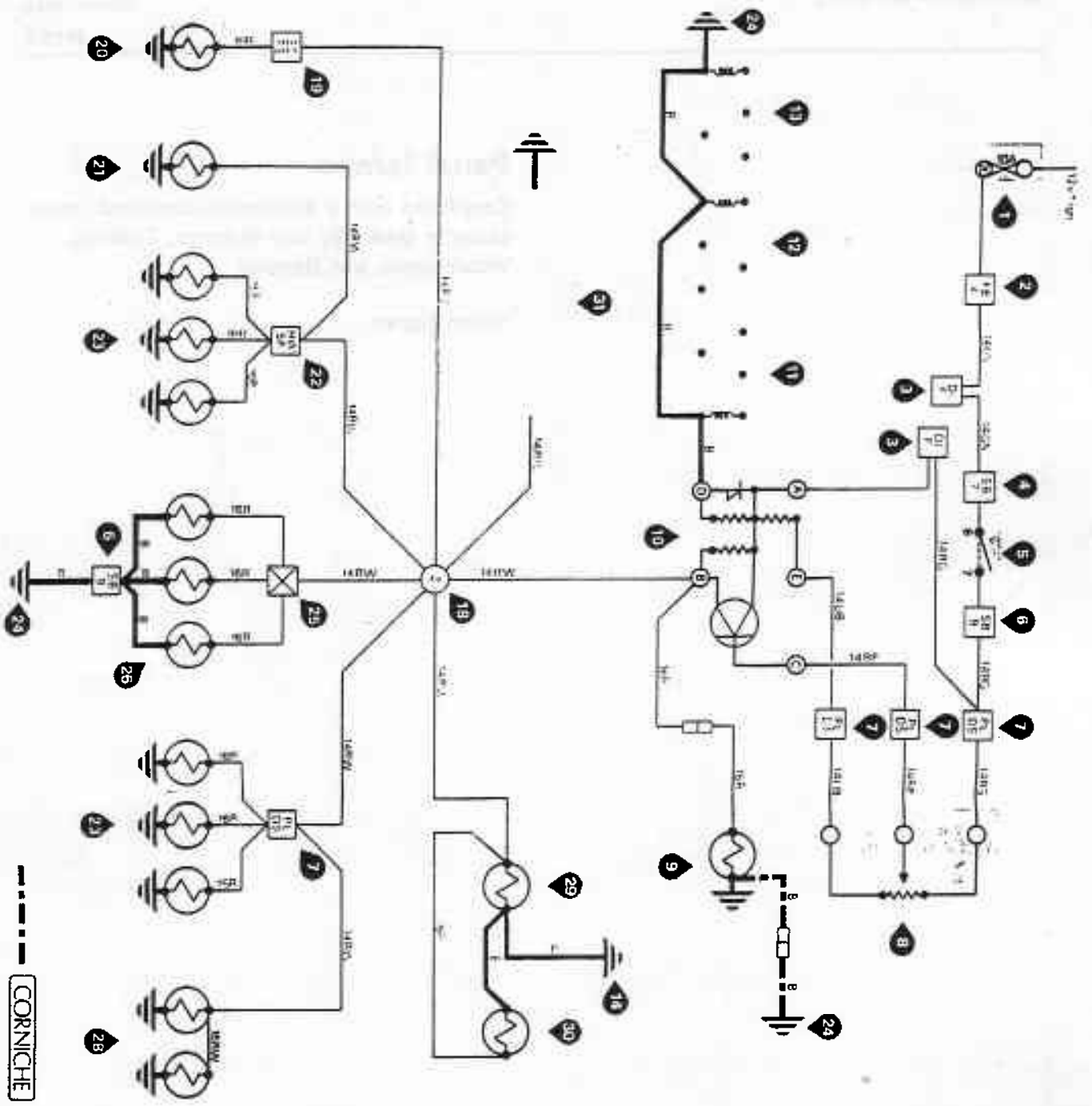

CORNICHE

Panel lamps

Component location

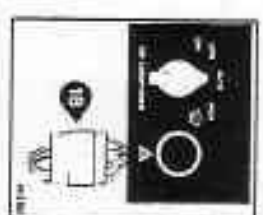
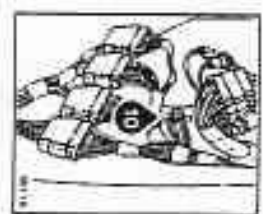
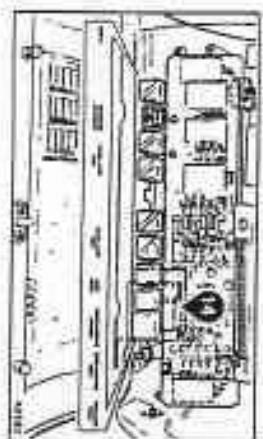
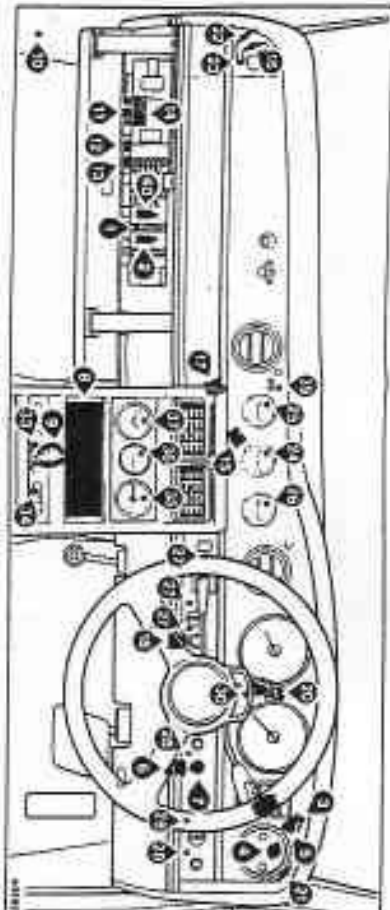
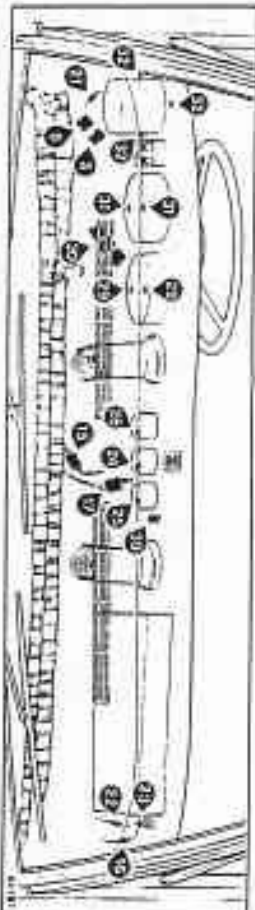
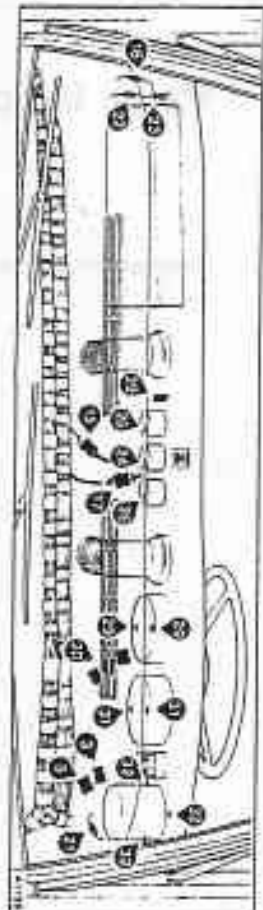
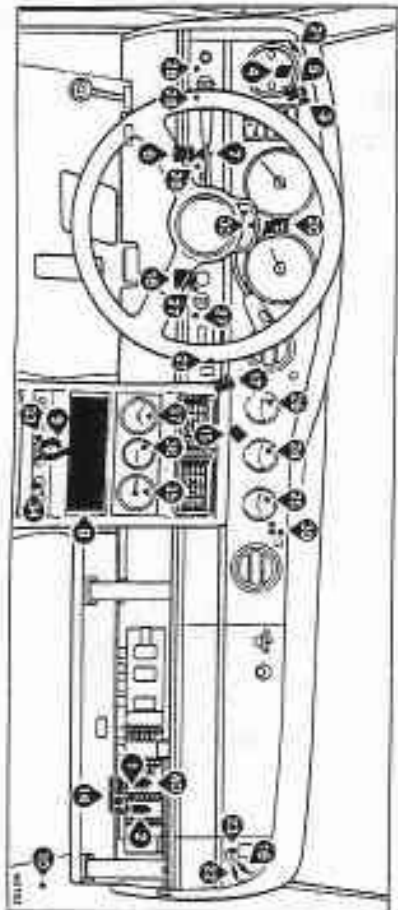

REAR SEAT	
1. REAR SEAT	1. REAR SEAT
2. REAR SEAT	2. REAR SEAT
3. REAR SEAT	3. REAR SEAT
4. REAR SEAT	4. REAR SEAT
5. REAR SEAT	5. REAR SEAT
6. REAR SEAT	6. REAR SEAT
7. REAR SEAT	7. REAR SEAT
8. REAR SEAT	8. REAR SEAT
9. REAR SEAT	9. REAR SEAT
10. REAR SEAT	10. REAR SEAT
11. REAR SEAT	11. REAR SEAT
12. REAR SEAT	12. REAR SEAT
13. REAR SEAT	13. REAR SEAT
14. REAR SEAT	14. REAR SEAT
15. REAR SEAT	15. REAR SEAT

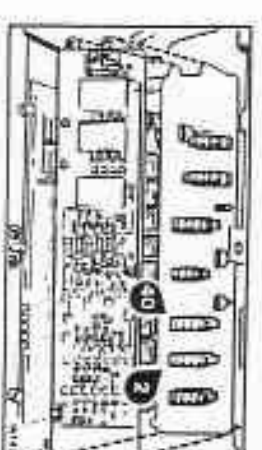
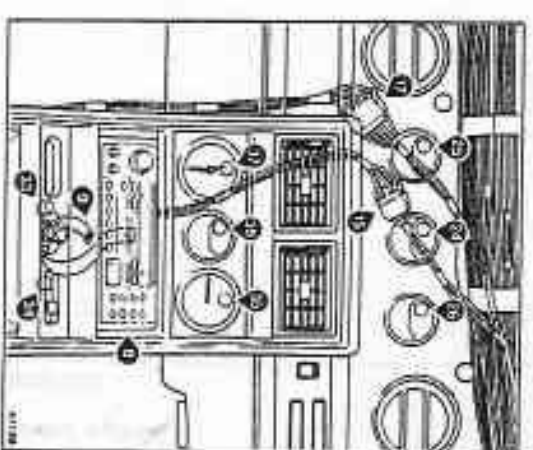
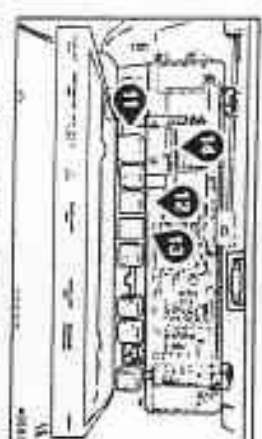
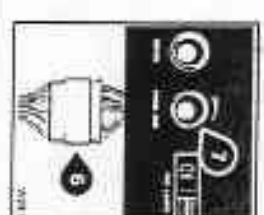

Panel lamps

Right-hand drive cars fitted with a Blaupunkt Toronto combined radio/cassette tape play unit

Wiring diagram

