

Centralized door locking system

On Silver Spirit, Silver Spur, and Mulsanne (including Turbo) cars built prior to vehicle identification number (VIN) *SCAZS42A3FCX12001* reference must be made to the illustrations on page M21-2 to determine which component location and wiring diagram to use for a particular car.

Contents	Pages					
	Silver Spirit Mulsanne	Silver Spur	Mulsanne Turbo	Bentley Eight	Bentley Turbo R	Corniche/ Continental
Cars prior to vehicle identification number *SCAZS42A3FCX12001*						
Component location	M21-3 or M21-7	M21-3 or M21-7	M21-3 or M21-7	M21-7	—	M21-7
Wiring diagram						
Right-hand drive cars	M21-5 or M21-9	M21-5 or M21-9	M21-5 or M21-9	M21-9	—	M21-11
Left-hand drive cars	M21-5 or M21-9	M21-5 or M21-9	M21-5 or M21-9	M21-9	—	M21-13
Cars from vehicle identification number *SCAZS42A3FCX12001*						
Component location	M21-15	M21-15	M21-15	M21-7	M21-15	M21-13/1
Wiring diagram						
Right-hand drive cars	M21-17	M21-17	M21-17	M21-9	M21-17	M21-13/3
Left-hand drive cars	M21-19	M21-19	M21-19	M21-9	M21-19	M21-13/5

M21-2

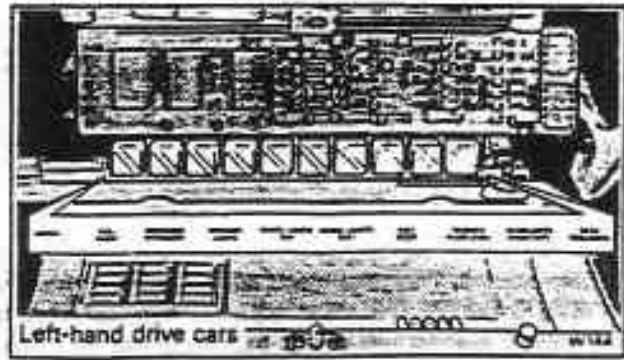
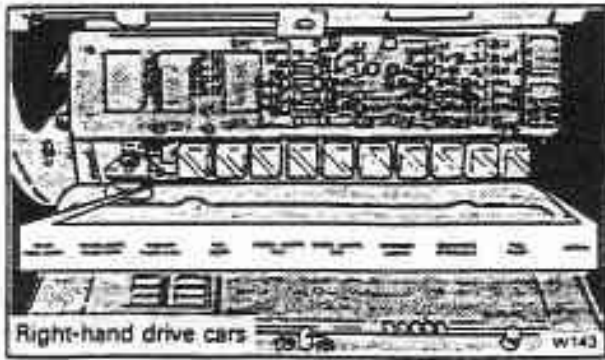

Fig. M21-1 Cars not fitted with Centralized door locking system relays. Refer to pages M21-3 and M21-5

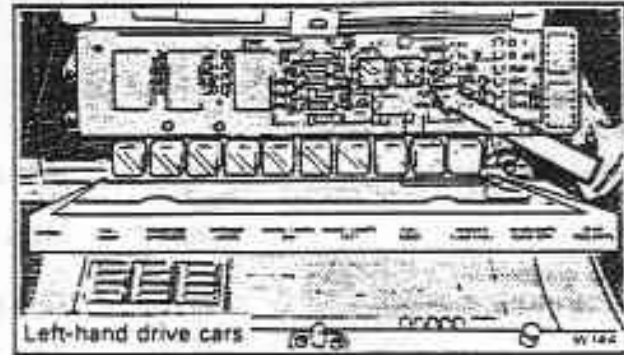
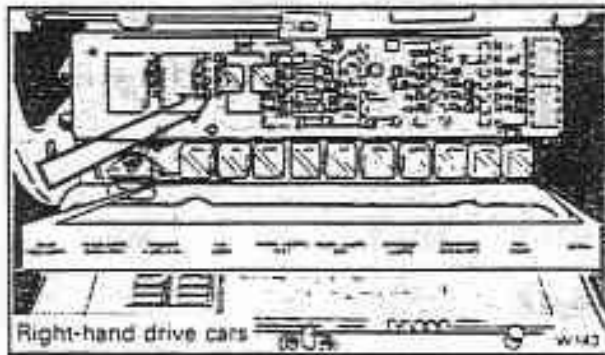
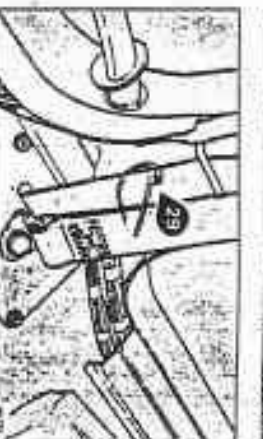
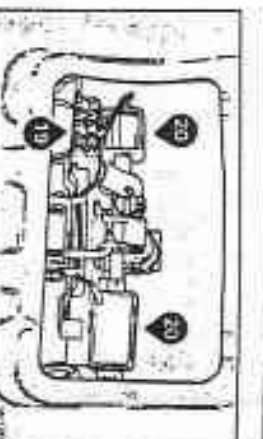
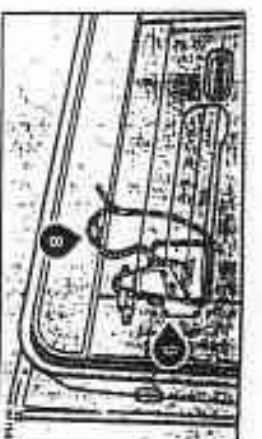
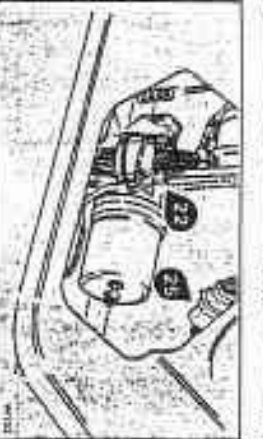
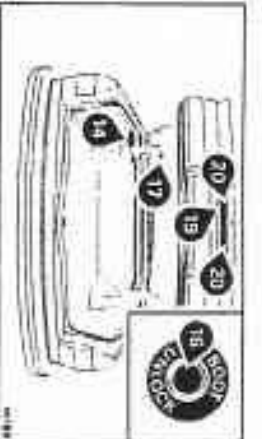
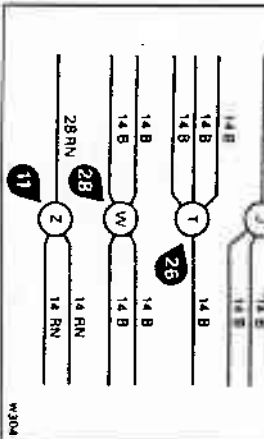
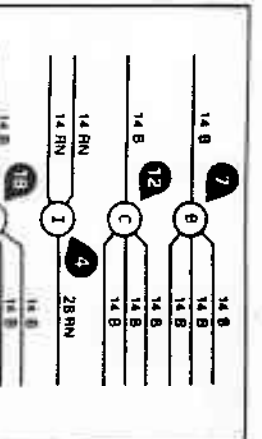
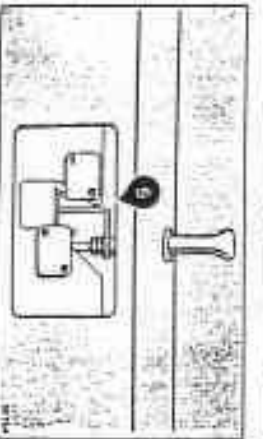
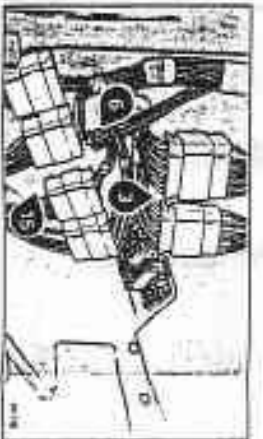
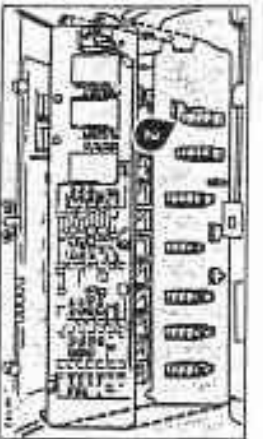
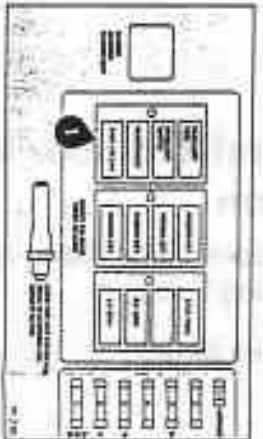
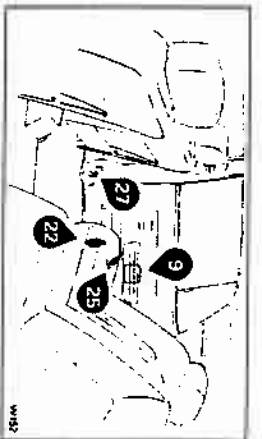
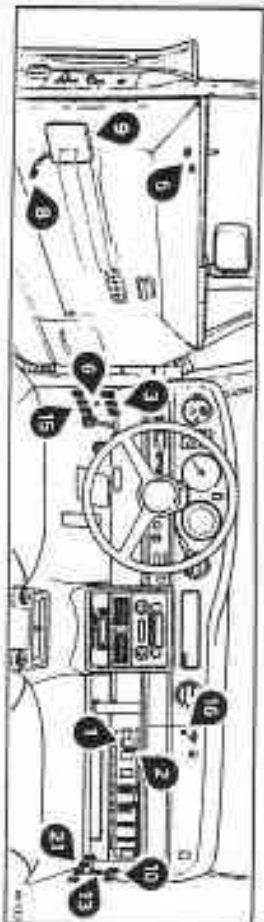
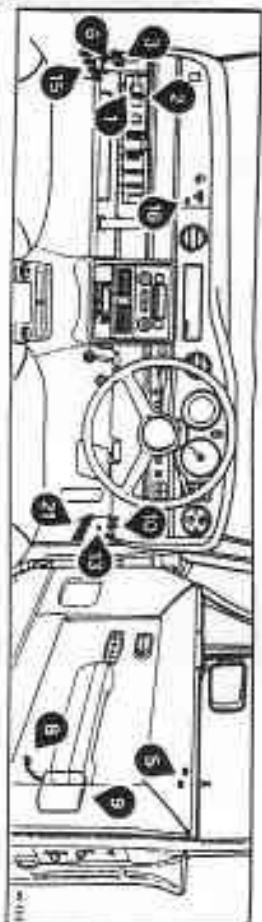

Fig. M21-2 Cars fitted with Centralized door locking system relays. Refer to pages M21-7 and M21-9

Centralized door locking system

**Silver Spirit, Silver Spur, and Mulsanne
(including Turbo)**

Component location



Centralized door locking system

**Silver Spirit, Silver Spur, and Mulsanne
(including Turbo)**

Wiring diagram

Centralized door locking system

**Silver Spirit, Silver Spur, and Mulsanne
(including Turbo)**

Wiring diagram

Centralized door locking system

Silver Spirit, Silver Spur, Mulsanne,
(including Turbo), Bentley Eight, and
Corniche/Continental

Component location

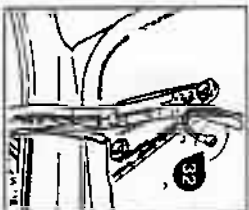
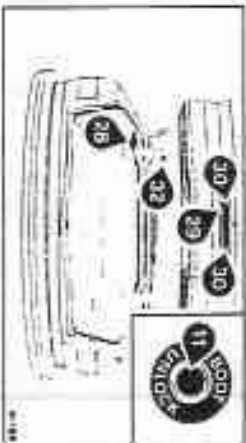
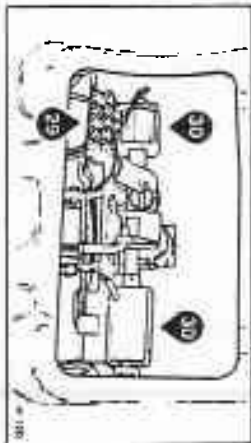
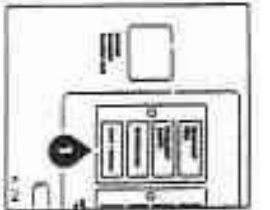
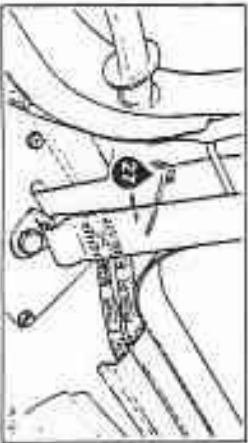
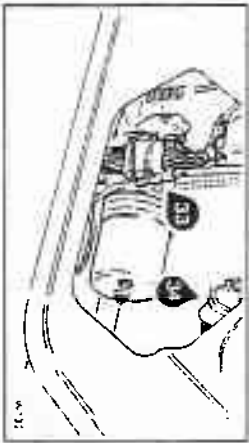
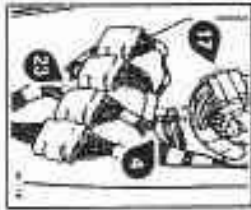
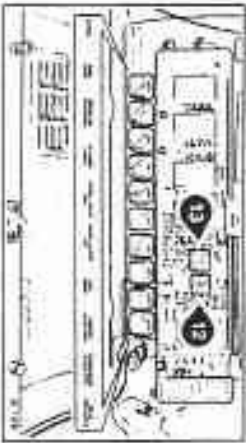
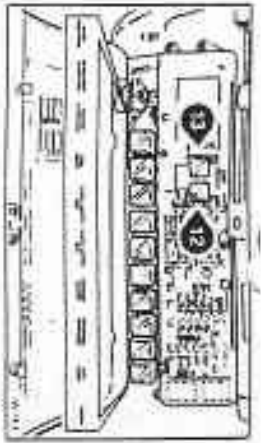
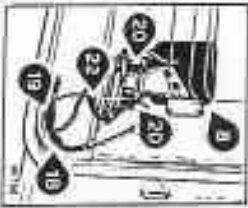
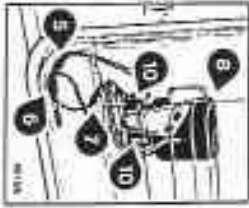
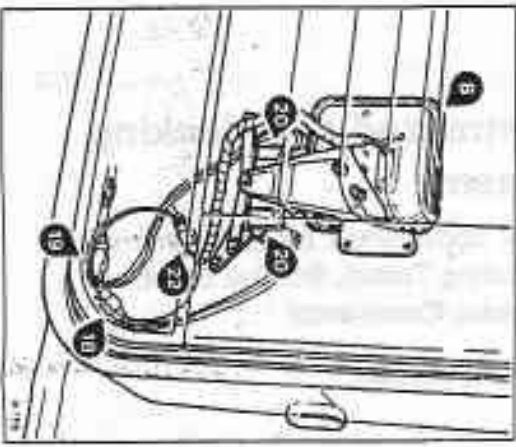
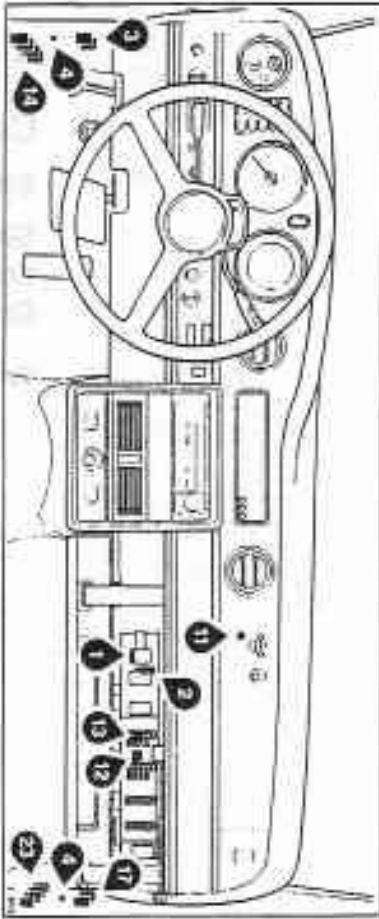
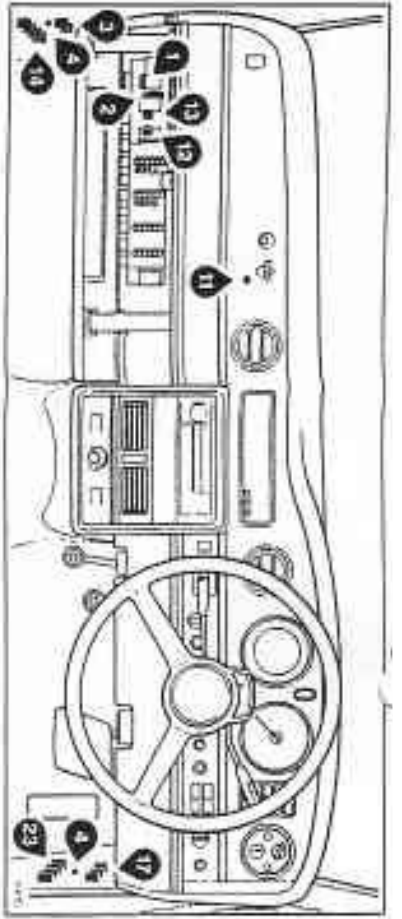

9	148	8	148	21	148	148	148
15	288K	Y	288K	26	148	W	148
16	288K	X	288K	31	148	J	148
	288K		288K	35	148	T	148

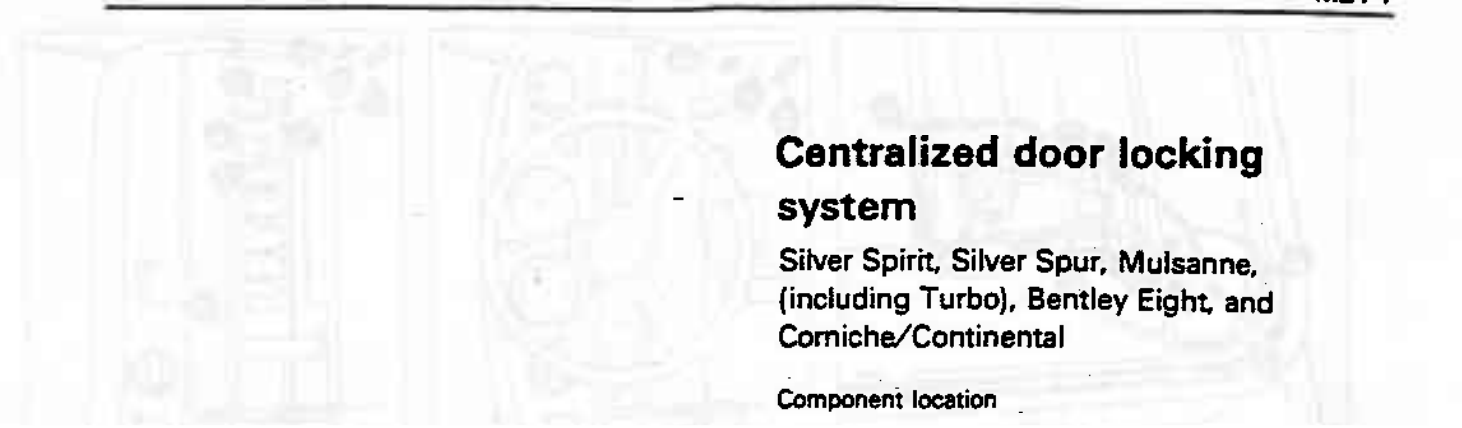

Centralized door locking system

Silver Spirit, Silver Spur, Mulsanne, (including Turbo), Bentley Eight, and Corniche/Continental

Component location

Centralized door locking system

Silver Spirit, Silver Spur, Mulsanne, (including Turbo), Bentley Eight, and Corniche/Continental

Component location

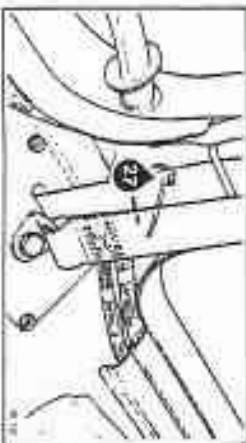
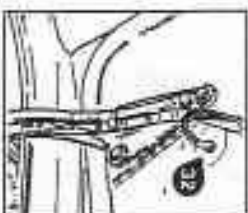
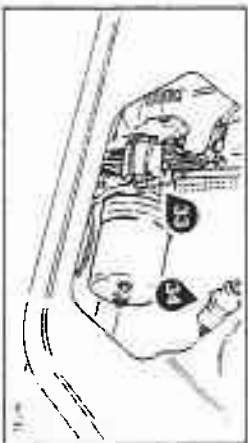
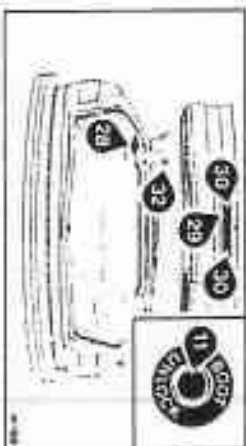
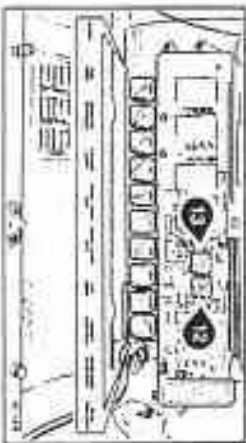
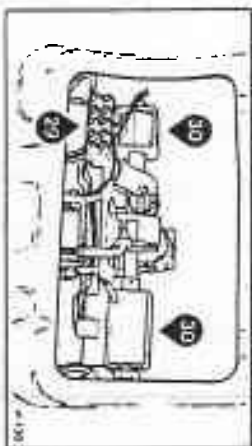
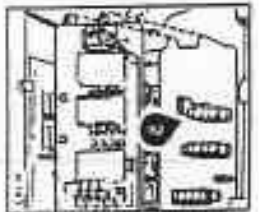
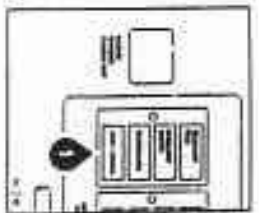
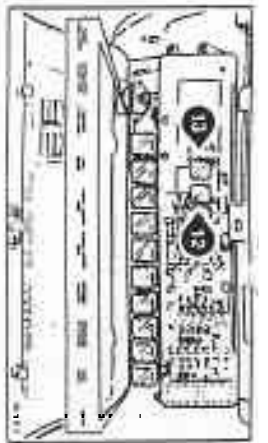
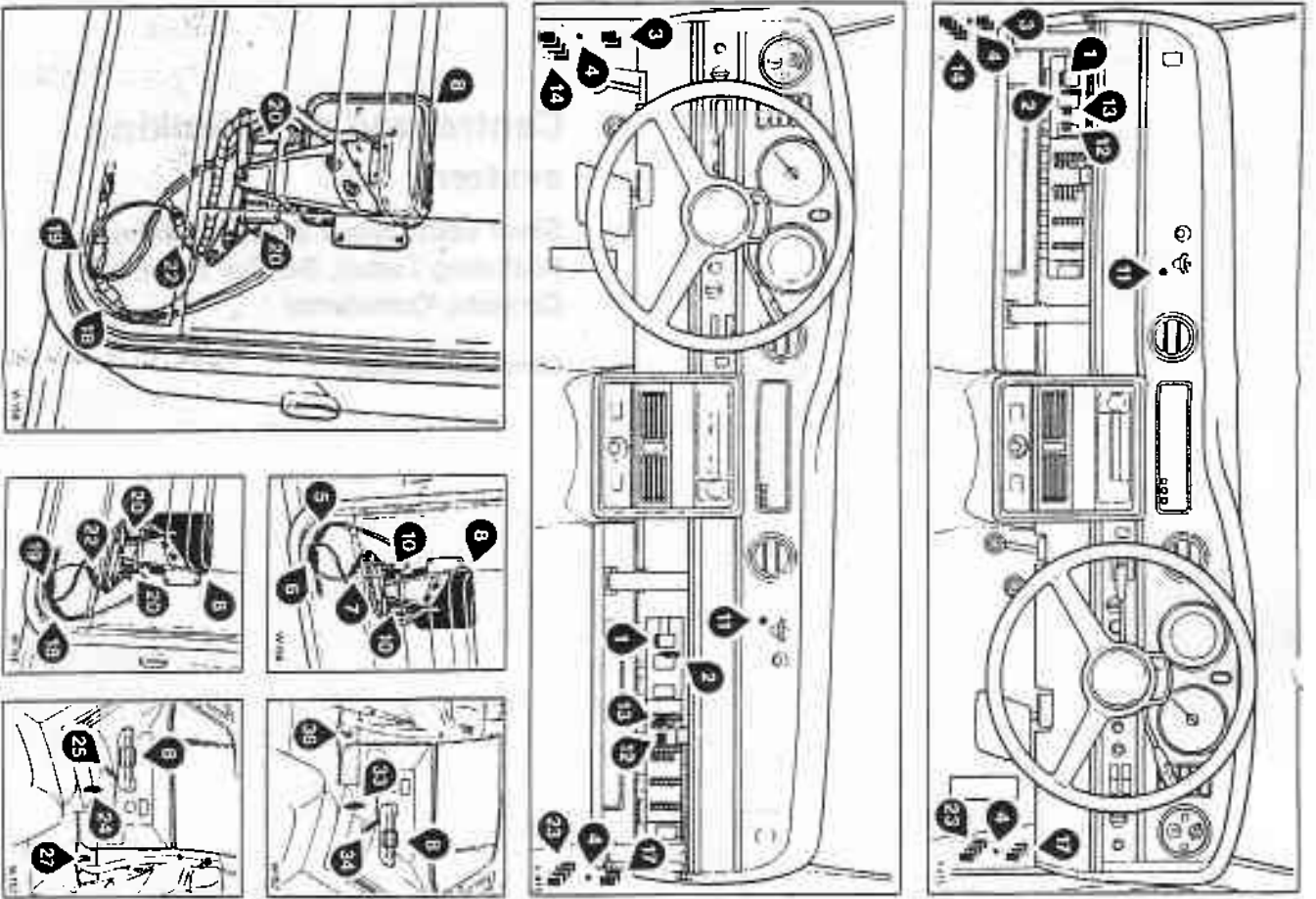

9	148	B	148	21	148	C	148
15	288K	Y	288K	26	148	W	148
16	288K	X	288K	31	148	J	148
	288K		288K	35	148	T	148

CORNICHE

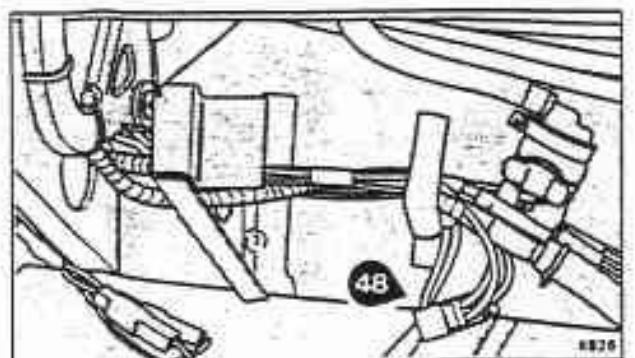
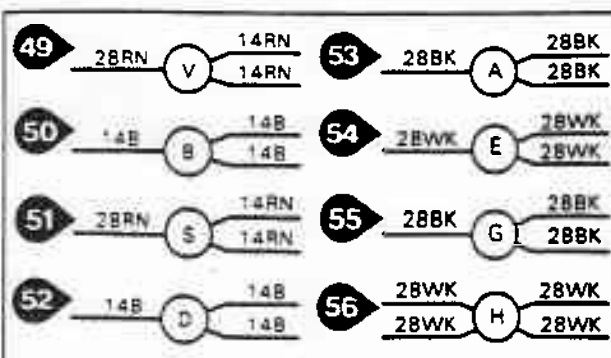
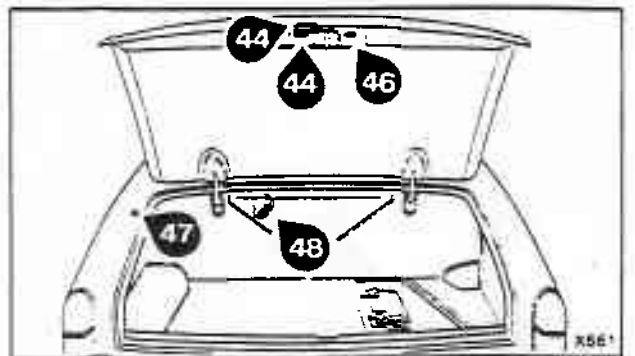
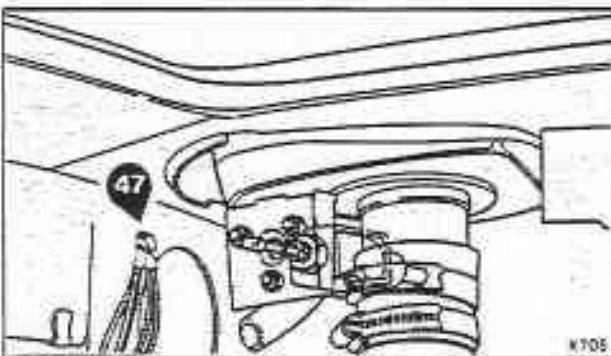
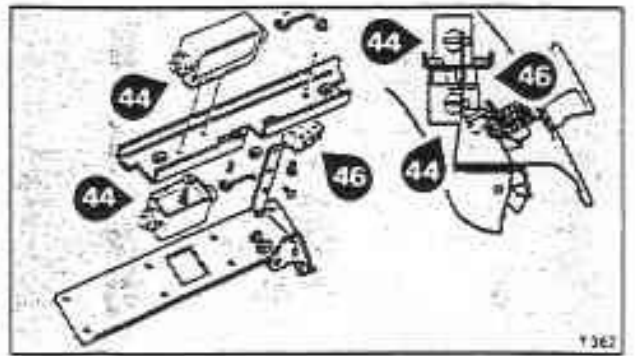
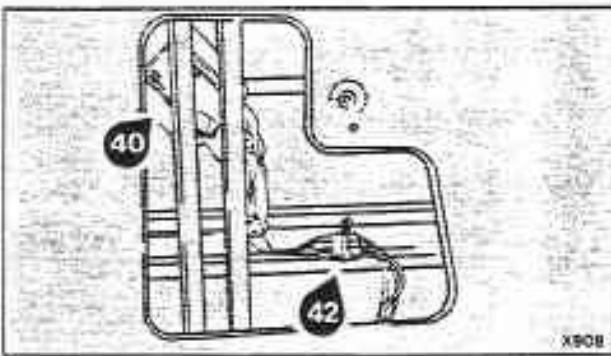
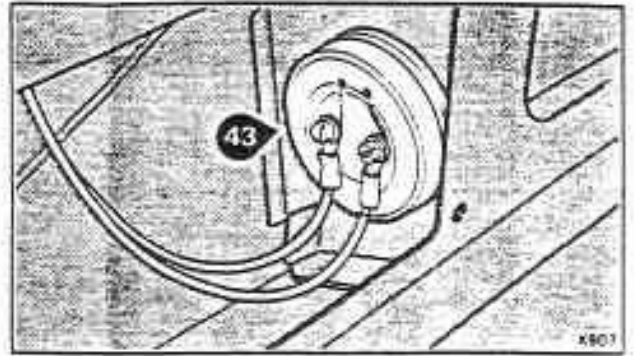
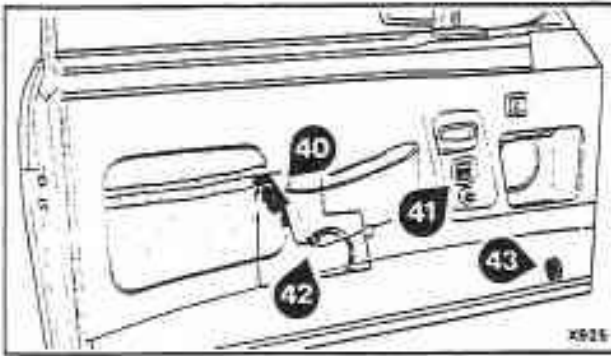
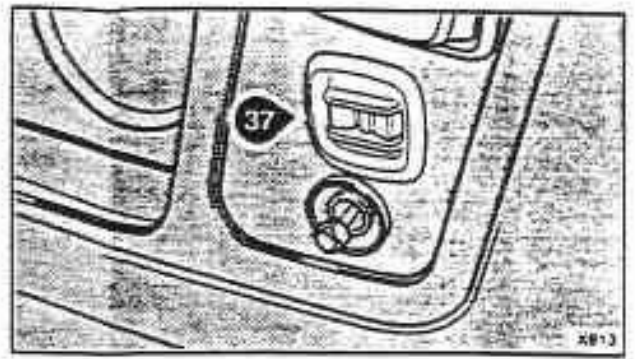
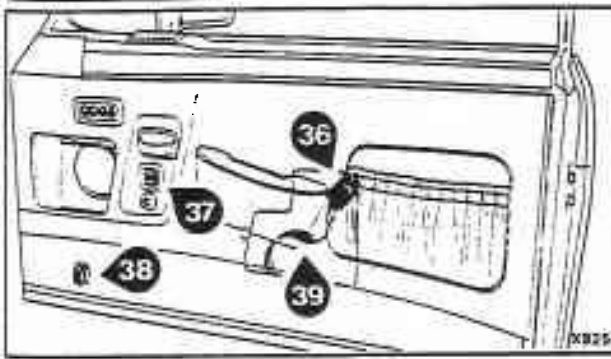

Centralized door locking system

Silver Spirit, Silver Spur, Mulsanne (including Turbo), and Bentley Eight

Wiring diagram

Centralized door locking system

Corniche/Continental

Right-hand drive cars

Wiring diagram

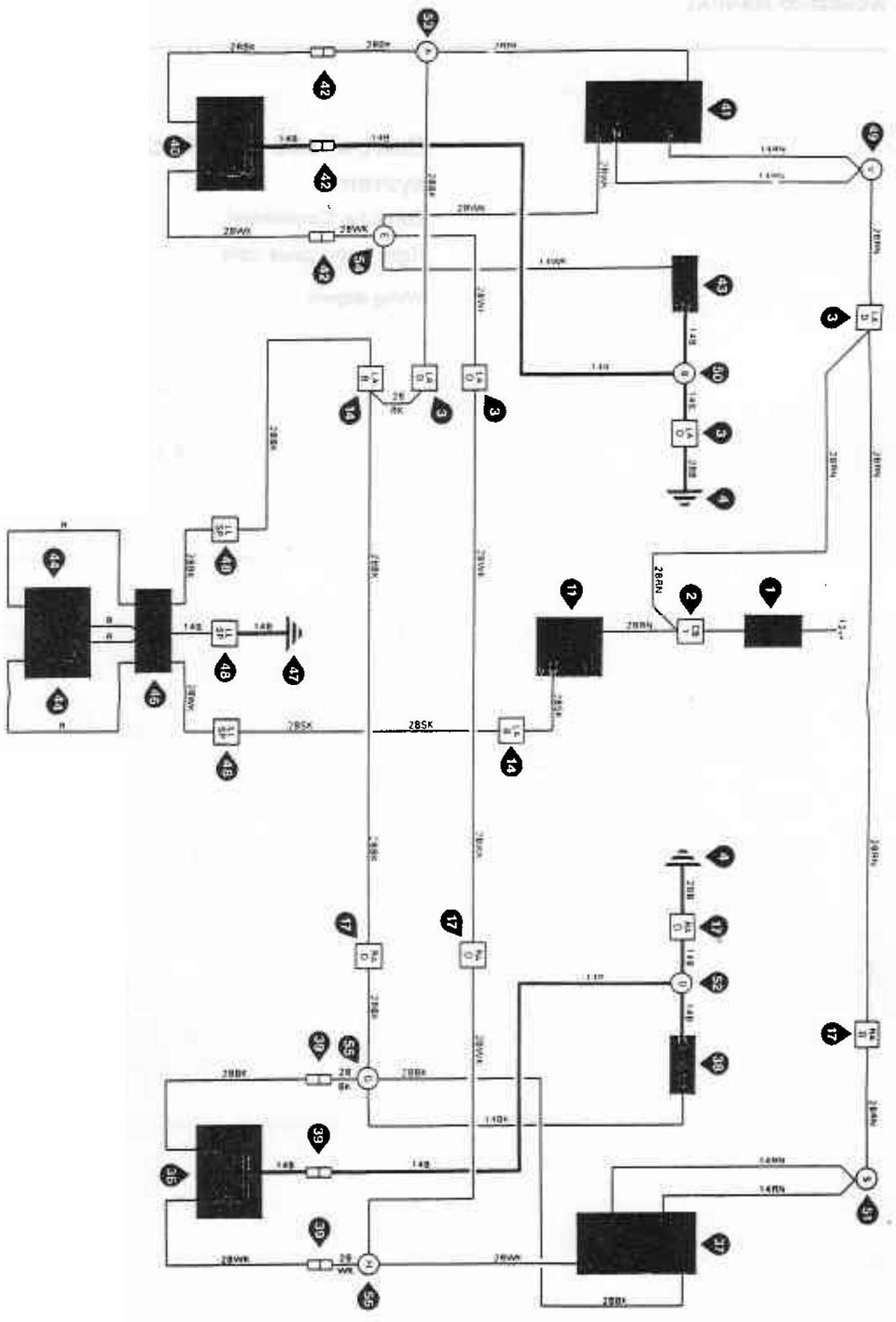

Centralized door locking system

Corniche/Continental

Left-hand drive cars

Wiring diagram

Centralized door locking system

Corniche/Continental

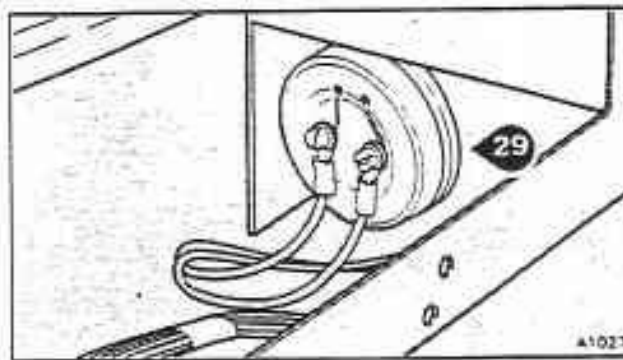
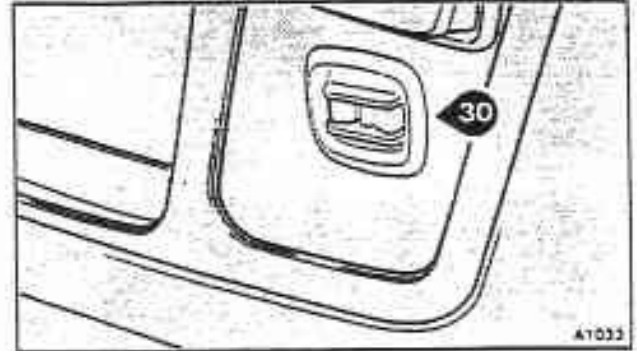
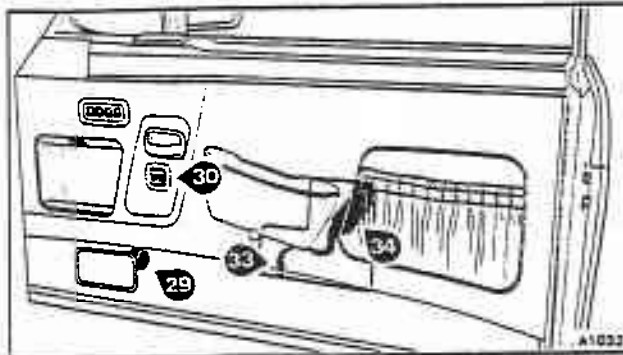
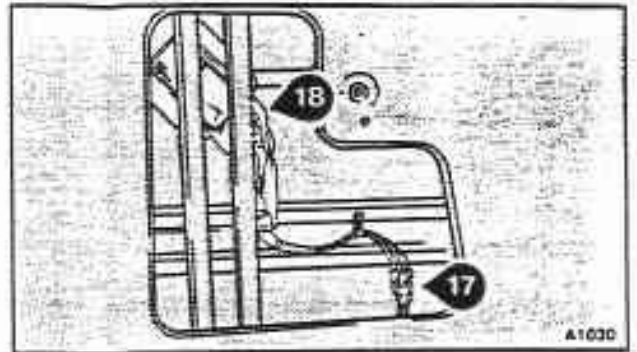
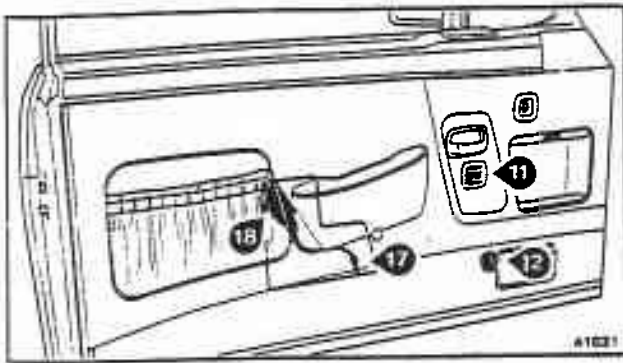

Centralized door locking system

Corniche/Continental

Right-hand drive cars

Wiring diagram

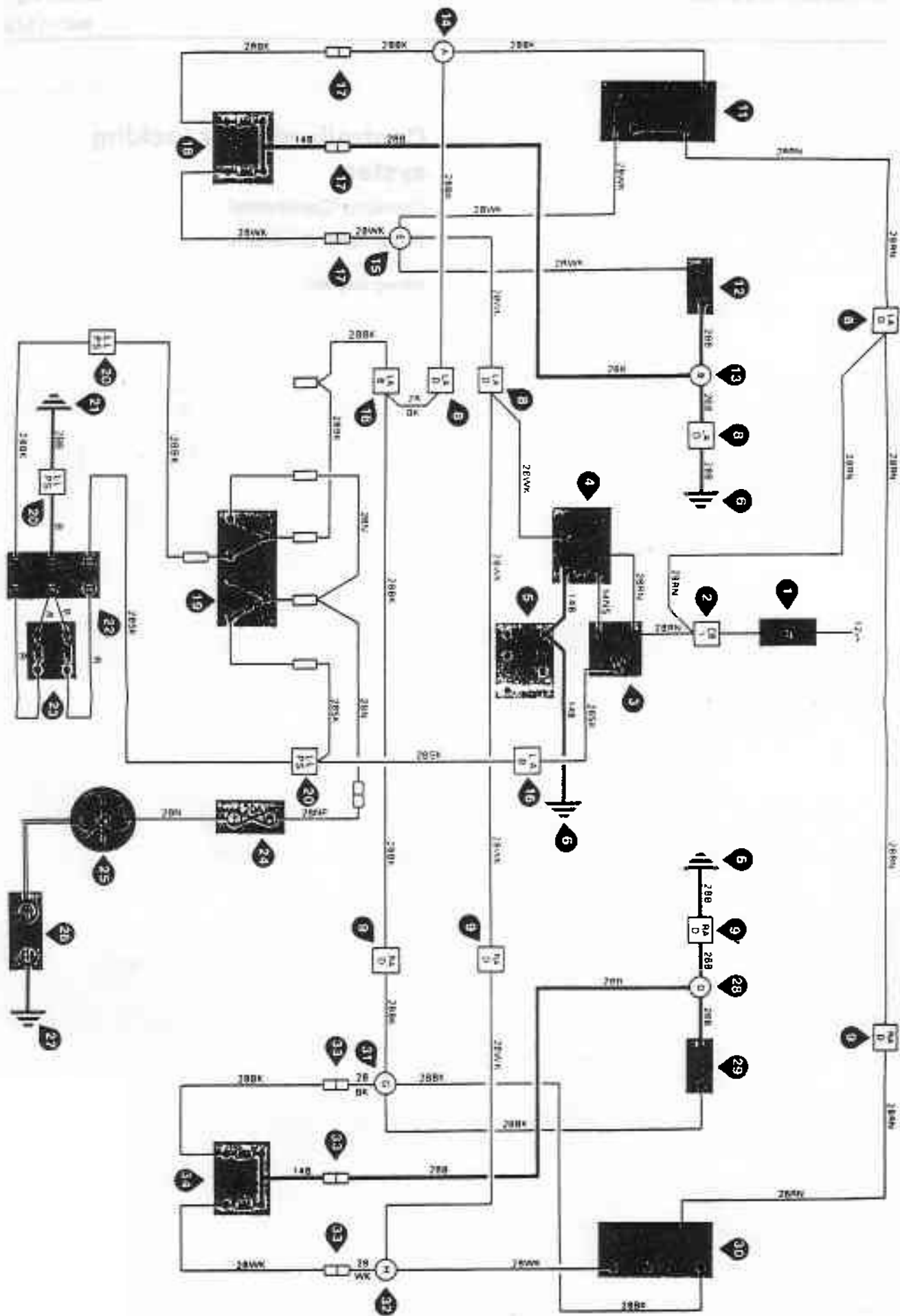

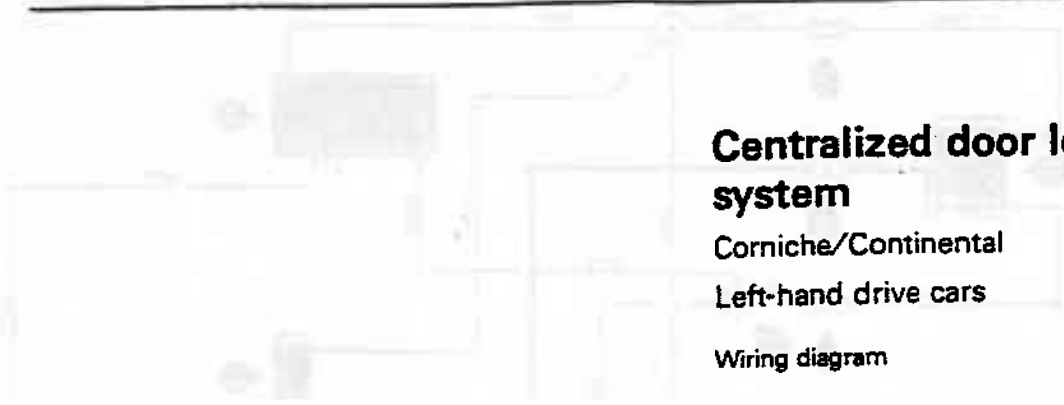

**Centralized door locking
system**

Corniche/Continental

Left-hand drive cars

Wiring diagram

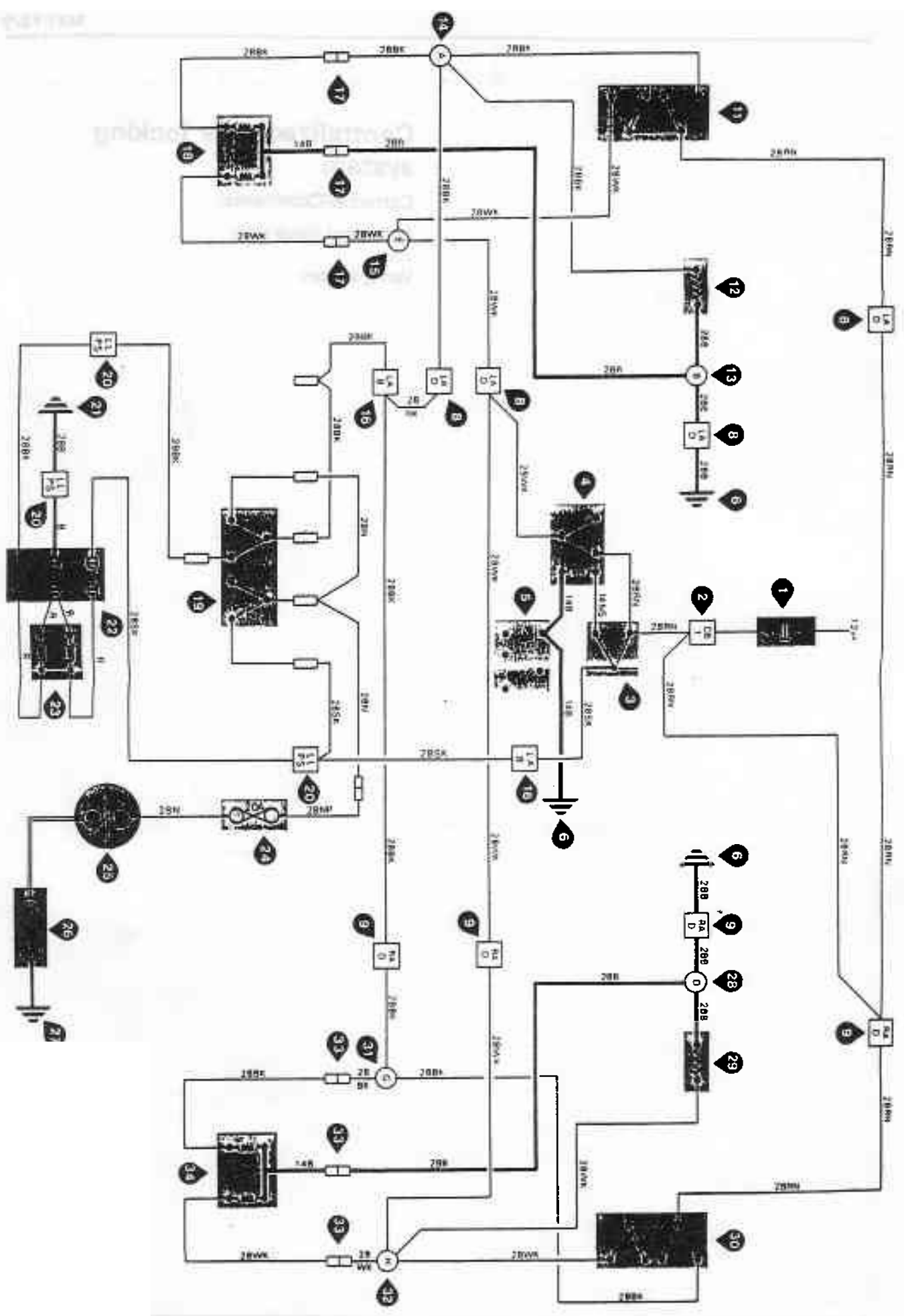

unblock

Centralized door locking system

Silver Spirit, Silver Spur, Mulsanne (including Turbo), and Turbo R

Component location

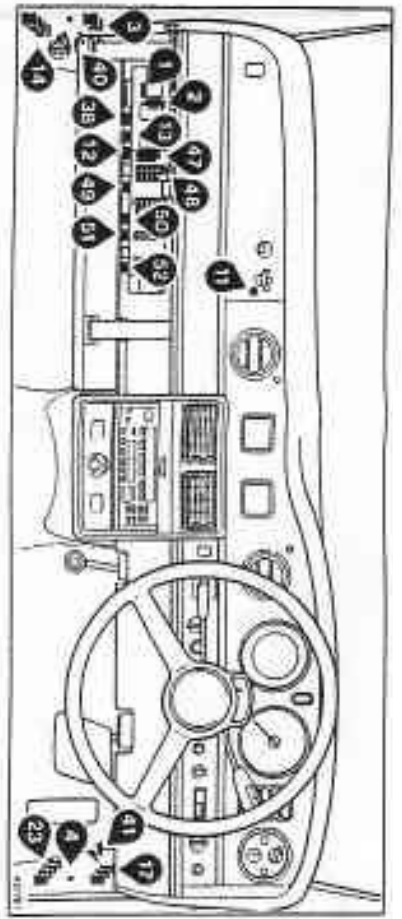
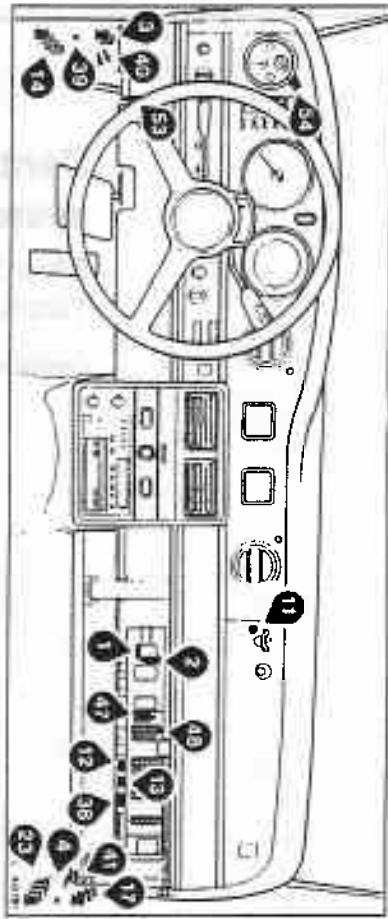
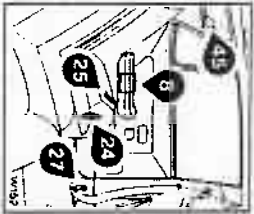
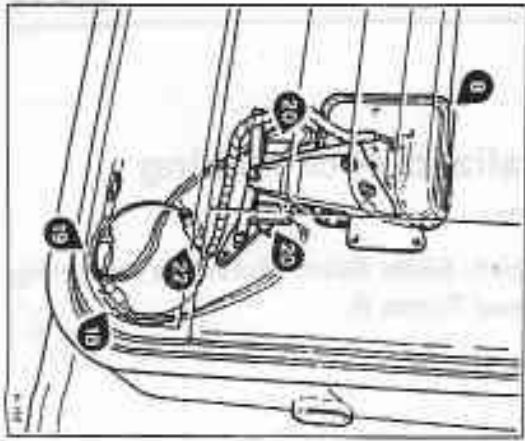

Callout	Component Name	Location
1	Ignition Switch	Driver's Side
2	Power Window Switch	Driver's Side
3	Power Lock Switch	Driver's Side
4	Power Mirror Switch	Driver's Side
5	Door Lock Switch	Driver's Side
6	Door Lock Release	Driver's Side
7	Door Lock Release	Driver's Side
8	Door Lock Release	Driver's Side
9	Door Lock Release	Driver's Side
10	Door Lock Release	Driver's Side
11	Door Lock Release	Driver's Side
12	Door Lock Release	Driver's Side
13	Door Lock Release	Driver's Side
14	Door Lock Release	Driver's Side
15	Door Lock Release	Driver's Side
16	Door Lock Release	Driver's Side
17	Door Lock Release	Driver's Side
18	Door Lock Release	Driver's Side
19	Door Lock Release	Driver's Side
20	Door Lock Release	Driver's Side
21	Door Lock Release	Driver's Side
22	Door Lock Release	Driver's Side
23	Door Lock Release	Driver's Side
24	Door Lock Release	Driver's Side
25	Door Lock Release	Driver's Side
26	Door Lock Release	Driver's Side
27	Door Lock Release	Driver's Side
28	Door Lock Release	Driver's Side
29	Door Lock Release	Driver's Side
30	Door Lock Release	Driver's Side
31	Door Lock Release	Driver's Side
32	Door Lock Release	Driver's Side
33	Door Lock Release	Driver's Side
34	Door Lock Release	Driver's Side
35	Door Lock Release	Driver's Side
36	Door Lock Release	Driver's Side
37	Door Lock Release	Driver's Side
38	Door Lock Release	Driver's Side
39	Door Lock Release	Driver's Side
40	Door Lock Release	Driver's Side
41	Door Lock Release	Driver's Side
42	Door Lock Release	Driver's Side
43	Door Lock Release	Driver's Side
44	Door Lock Release	Driver's Side
45	Door Lock Release	Driver's Side
46	Door Lock Release	Driver's Side
47	Door Lock Release	Driver's Side
48	Door Lock Release	Driver's Side
49	Door Lock Release	Driver's Side
50	Door Lock Release	Driver's Side
51	Door Lock Release	Driver's Side
52	Door Lock Release	Driver's Side
53	Door Lock Release	Driver's Side

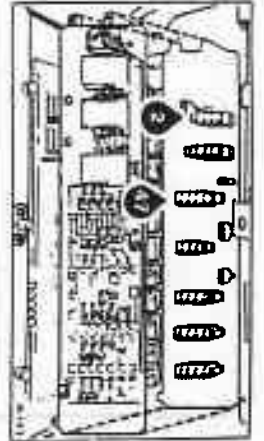
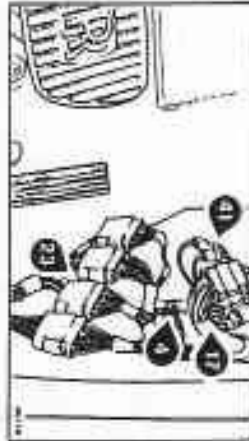
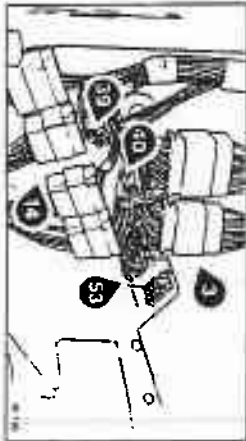
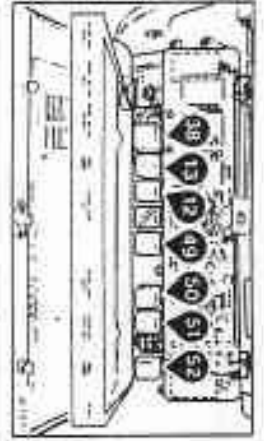
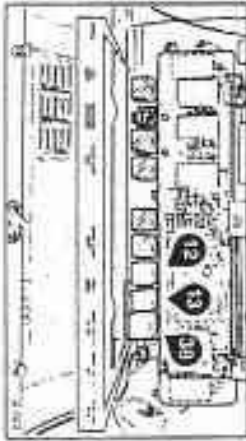
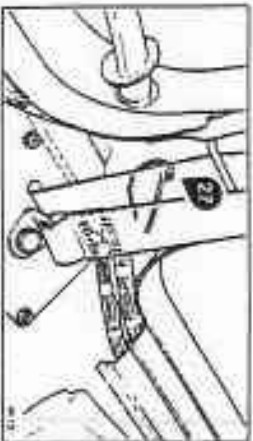

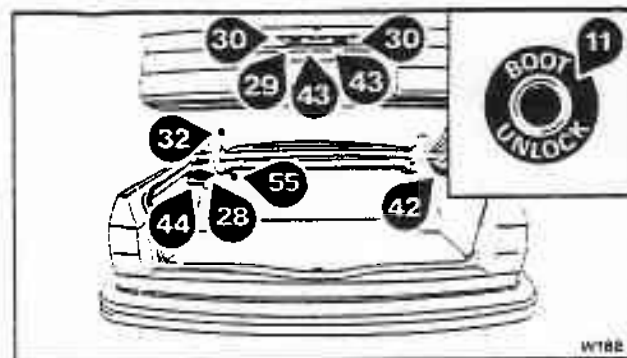
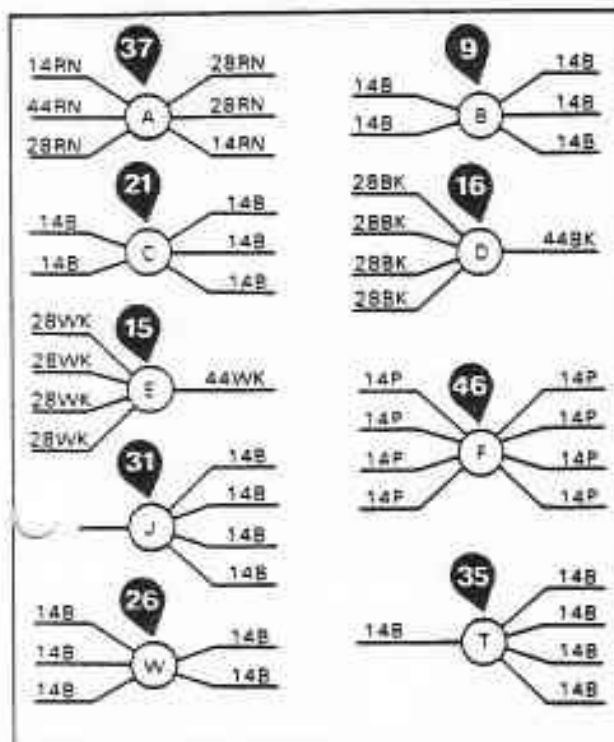
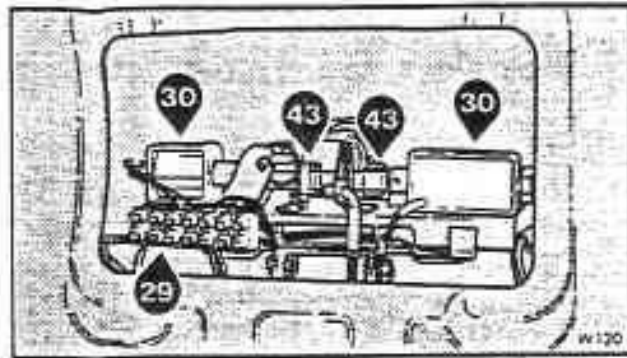
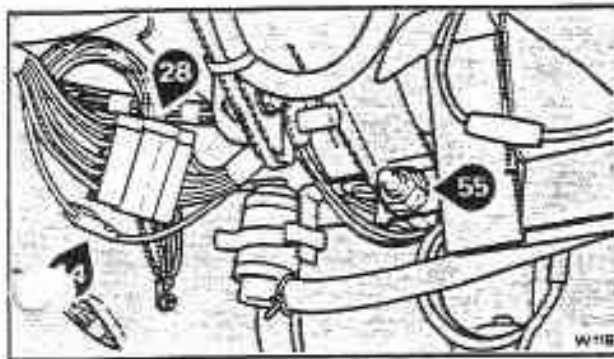
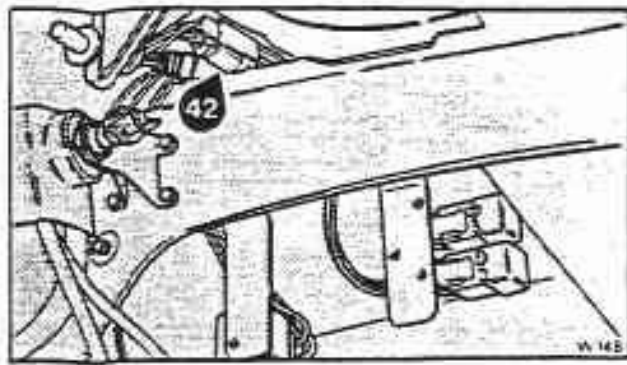
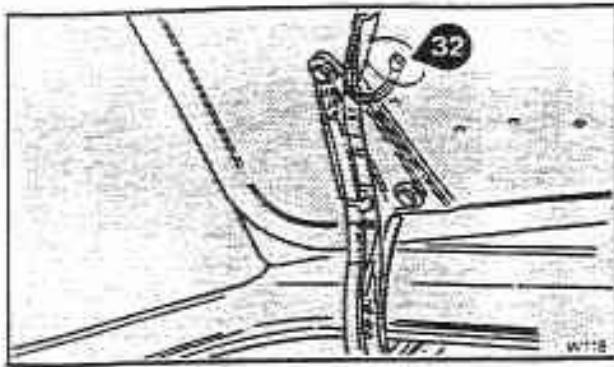

Centralized door locking system

Silver Spirit, Silver Spur, Mulsanne (including Turbo), and Turbo R

Right-hand drive cars

Wiring diagram

Centralized door locking system

Silver Spirit, Silver Spur, Mulsanne (including Turbo), and Turbo R

Left-hand drive cars

Wiring diagram

